



UML Tutorial

Tutorialspoint.com

UML is a standard language for specifying, visualizing, constructing, and documenting the artifacts of software systems.

UML was created by Object Management Group and UML 1.0 specification draft was proposed to the OMG in January 1997. This tutorial gives an initial push to start you with UML. For more detail kindly check tutorialspoint.com/uml

UML is a standard language for specifying, visualizing, constructing, and documenting the artifacts of software systems.

UML was created by Object Management Group (OMG) and UML 1.0 specification draft was proposed to the OMG in January 1997.

OMG is continuously putting effort to make a truly industry standard.

- UML stands for **U**nified **M**odelling **L**anguage.
- UML is different from the other common programming languages like C++, Java, COBOL etc.
- UML is a pictorial language used to make software blue prints.

So UML can be described as a general purpose visual modelling language to visualize, specify, construct and document software system. Although UML is generally used to model software systems but it is not limited within this boundary. It is also used to model non software systems as well like process flow in a manufacturing unit etc.

UML is not a programming language but tools can be used to generate code in various languages using UML diagrams. UML has a direct relation with object oriented analysis and design. After some standardization UML is become an OMG (Object Management Group) standard.

Goals of UML:

A picture is worth a thousand words, this absolutely fits while discussing about UML. Object oriented concepts were introduced much earlier than UML. So at that time there were no standard methodologies to organize and consolidate the object oriented development. At that point of time UML came into picture.

There are a number of goals for developing UML but the most important is to define some general purpose modelling language which all modelers can use and also it needs to be made simple to understand and use.

UML diagrams are not only made for developers but also for business users, common people and anybody interested to understand the system. The system can be a software or non software. So it must be clear that UML is not a development method rather it accompanies with processes to make a successful system.

At the conclusion the goal of UML can be defined as a simple modelling mechanism to model all possible practical systems in today's complex environment.

A conceptual model of UML:

To understand conceptual model of UML first we need to clarify *What is a conceptual model?* and *Why a conceptual model is at all required?*

- A conceptual model can be defined as a model which is made of concepts and their relationships.
- A conceptual model is the first step before drawing a UML diagram. It helps to understand the entities in the real world and how they interact with each other.

As UML describes the real time systems it is very important to make a conceptual model and then proceed gradually. Conceptual model of UML can be mastered by learning the following three major elements:

- UML building blocks
- Rules to connect the building blocks
- Common mechanisms of UML

Object oriented concepts:

UML can be described as the successor of object oriented analysis and design.

An object contains both data and methods that control the data. The data represents the state of the object. A class describes an object and they also form hierarchy to model real world system. The hierarchy is represented as inheritance and the classes can also be associated in different manners as per the requirement.

The objects are the real world entities that exist around us and the basic concepts like abstraction, encapsulation, inheritance, polymorphism all can be represented using UML.

So UML is powerful enough to represent all the concepts exists in object oriented analysis and design. UML diagrams are representation of object oriented concepts only. So before learning UML, it becomes important to understand OO concepts in details.

Following are some fundamental concepts of object oriented world:

- **Objects:** Objects represent an entity and the basic building block.
- **Class:** Class is the blue print of an object.
- **Abstraction:** Abstraction represents the behavior of an real world entity.
- **Encapsulation:** Encapsulation is the mechanism of binding the data together and hiding them from outside world.
- **Inheritance:** Inheritance is the mechanism of making new classes from existing one.
- **Polymorphism:** It defines the mechanism to exists in different forms.

OO Analysis and Design

Object Oriented analysis can be defined as investigation and to be more specific it is the investigation of objects. Design means collaboration of identified objects.

So it is important to understand the OO analysis and design concepts. Now the most important purpose of OO analysis is to identify objects of a system to be designed. This analysis is also done for an existing system. Now an efficient analysis is only possible when we are able to start thinking in a way where objects can be identified. After identifying the objects their relationships are identified and finally the design is produced.

So the purpose of OO analysis and design can described as:

- Identifying the objects of a system.
- Identify their relationships.
- Make a design which can be converted to executables using OO languages.

There are three basic steps where the OO concepts are applied and implemented. The steps can be defined as

OO Analysis --> OO Design --> OO implementation using OO languages

Now the above three points can be described in details:

- During object oriented analysis the most important purpose is to identify objects and describing them in a proper way. If these objects are identified efficiently then the next job of design is easy. The objects should be identified with responsibilities. Responsibilities are the functions performed by the object. Each and every object has some type of responsibilities to be performed. When these responsibilities are collaborated the purpose of the system is fulfilled.
- The second phase is object oriented design. During this phase emphasis is given upon the requirements and their fulfilment. In this stage the objects are collaborated according to their intended association. After the association is complete the design is also complete.
- The third phase is object oriented implementation. In this phase the design is implemented using object oriented languages like Java, C++ etc.

Role of UML in OO design:

UML is a modelling language used to model software and non software systems. Although UML is used for non software systems the emphasis is on modelling object oriented software applications. Most of the UML diagrams discussed so far are used to model different aspects like static, dynamic etc. Now what ever be the aspect the artifacts are nothing but objects.

If we look into class diagram, object diagram, collaboration diagram, interaction diagrams all would basically be designed based on the objects.

So the relation between OO design and UML is very important to understand. The OO design is transformed into UML diagrams according to the requirement. Before understanding the UML in details the OO concepts should be learned properly. Once the OO analysis and design is done the next step is very easy. The input from the OO analysis and design is the input to the UML diagrams.

UML Building Blocks:

As UML describes the real time systems it is very important to make a conceptual model and then proceed gradually. Conceptual model of UML can be mastered by learning the following three major elements:

- UML building blocks
- Rules to connect the building blocks
- Common mechanisms of UML

This chapter describes all the UML building blocks. The building blocks of UML can be defined as:

- Things
- Relationships
- Diagrams

(1) Things:

Things are the most important building blocks of UML. Things can be:

- Structural
- Behavioral
- Grouping
- Annotational

Structural things:

The **Structural things** define the static part of the model. They represent physical and conceptual elements. Following are the brief descriptions of the structural things.

Class:

Class represents set of objects having similar responsibilities.



Interface:

Interface defines a set of operations which specify the responsibility of a class.



Collaboration:

Collaboration defines interaction between elements.



Use case:

Use case represents a set of actions performed by a system for a specific goal.

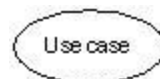

Component:

Component describes physical part of a system.

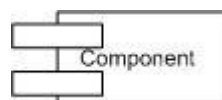

Node:

A node can be defined as a physical element that exists at run time.

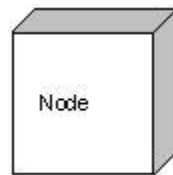

Behavioral things:

A behavioral thing consists of the dynamic parts of UML models. Following are the behavioral things:

Interaction:

Interaction is defined as a behavior that consists of a group of messages exchanged among elements to accomplish a specific task.

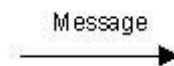

State machine:

State machine is useful when the state of an object in its life cycle is important. It defines the sequence of states an object goes through in response to events. Events are external factors responsible for state change.



Grouping things:

Grouping things can be defined as a mechanism to group elements of a UML model together. There is only one grouping thing available:

Package:

Package is the only one grouping thing available for gathering structural and behavioral things.



Annotational things:

Annotational things can be defined as a mechanism to capture remarks, descriptions, and comments of UML model elements. **Note** is the only one Annotational thing available.

Note:

A note is used to render comments, constraints etc of an UML element.

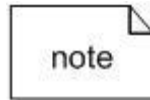

(2) Relationship :

Relationship is another most important building block of UML. It shows how elements are associated with each other and this association describes the functionality of an application.

There are four kinds of relationships available.

Dependency:

Dependency is a relationship between two things in which change in one element also affects the other one.

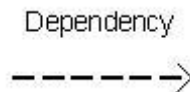

Association:

Association is basically a set of links that connects elements of an UML model. It also describes how many objects are taking part in that relationship.

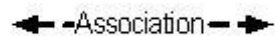

Generalization:

Generalization can be defined as a relationship which connects a specialized element with a generalized element. It basically describes inheritance relationship in the world of objects.

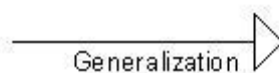

Realization:

Realization can be defined as a relationship in which two elements are connected. One element describes some responsibility which is not implemented and the other one implements them. This relationship exists in case of interfaces.

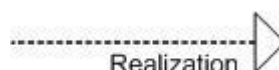

(3) UML Diagrams:

UML diagrams are the ultimate output of the entire discussion. All the elements, relationships are used to make a complete UML diagram and the diagram represents a system.

The visual effect of the UML diagram is the most important part of the entire process. All the other elements are used to make it a complete one.

UML includes the following nine diagrams and the details are described in the following chapters.

1. Class diagram
2. Object diagram
3. Use case diagram
4. Sequence diagram
5. Collaboration diagram
6. Activity diagram
7. Statechart diagram
8. Deployment diagram
9. Component diagram

We would discuss all these diagrams in subsequent chapters of this tutorial.

UML Architecture

Any real world system is used by different users. The users can be developers, testers, business people, analysts and many more. So before designing a system the architecture is made with different perspectives in mind. The most important part is to visualize the system from different viewer's perspective. The better we understand the better we make the system.

UML plays an important role in defining different perspectives of a system. These perspectives are:

- Design
- Implementation
- Process
- Deployment

And the centre is the **Use Case** view which connects all these four. A **Use case** represents the functionality of the system. So the other perspectives are connected with use case.

- **Design** of a system consists of classes, interfaces and collaboration. UML provides class diagram, object diagram to support this.
- **Implementation** defines the components assembled together to make a complete physical system. UML component diagram is used to support implementation perspective.
- **Process** defines the flow of the system. So the same elements as used in *Design* are also used to support this perspective.
- **Deployment** represents the physical nodes of the system that forms the hardware. UML deployment diagram is used to support this perspective.

UML Modelling Types

It is very important to distinguish between the UML model. Different diagrams are used for different type of UML modelling. There are three important type of UML modellings:

Structural modelling:

Structural modelling captures the static features of a system. They consist of the followings:

- Classes diagrams
- Objects diagrams
- Deployment diagrams

- Package diagrams
- Composite structure diagram
- Component diagram

Structural model represents the framework for the system and this framework is the place where all other components exist. So the class diagram, component diagram and deployment diagrams are the part of structural modelling. They all represent the elements and the mechanism to assemble them.

But the structural model never describes the dynamic behavior of the system. Class diagram is the most widely used structural diagram.

Behavioral Modelling:

Behavioral model describes the interaction in the system. It represents the interaction among the structural diagrams. Behavioral modelling shows the dynamic nature of the system. They consist of the following:

- Activity diagrams
- Interaction diagrams
- Use case diagrams

All the above show the dynamic sequence of flow in a system.

Architectural Modelling:

Architectural model represents the overall framework of the system. It contains both structural and behavioral elements of the system. Architectural model can be defined as the blue print of the entire system. Package diagram comes under architectural modelling.

UML Basic Notations

UML is popular for its diagrammatic notations. We all know that UML is for visualizing, specifying, constructing and documenting the components of software and non software systems. Here the *Visualization* is the most important part which needs to be understood and remembered by heart.

UML notations are the most important elements in modelling. Efficient and appropriate use of notations is very important for making a complete and meaningful model. The model is useless unless its purpose is depicted properly.

So learning notations should be emphasized from the very beginning. Different notations are available for things and relationships. And the UML diagrams are made using the notations of things and relationships. Extensibility is another important feature which makes UML more powerful and flexible.

The chapter describes the UML Basic Notations in more details. This is just an extension to the UML building block section I have discussed in previous chapter.

Structural Things:

Graphical notations used in structural things are the most widely used in UML. These are considered as the nouns of UML models. Following are the list of structural things.

- Classes
- Interface

- Collaboration
- Use case
- Active classes
- Components
- Nodes

Class Notation:

UML *class* is represented by the diagram shown below. The diagram is divided into four parts.

- The top section is used to name the class.
- The second one is used to show the attributes of the class.
- The third section is used to describe the operations performed by the class.
- The fourth section is optional to show any additional components.

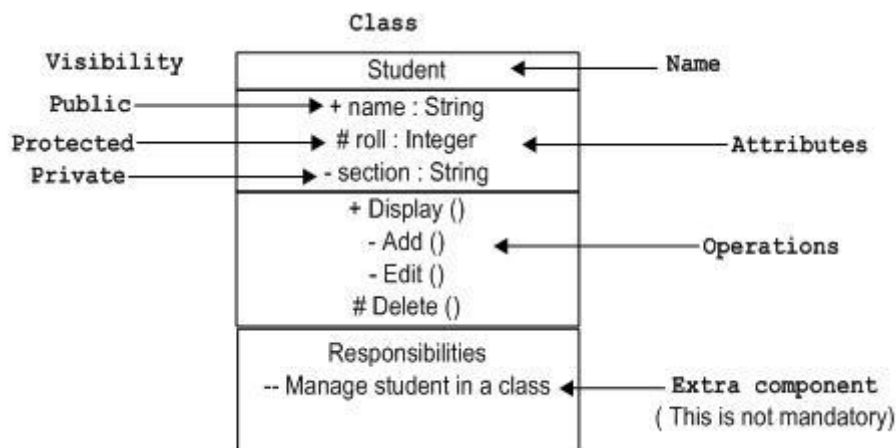

Classes are used to represent objects. Objects can be anything having properties and responsibility.

Object Notation:

The *object* is represented in the same way as the class. The only difference is the *name* which is underlined as shown below.

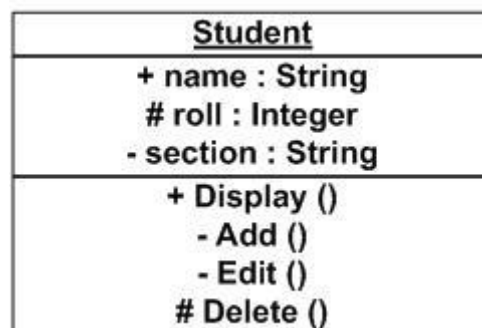

As object is the actual implementation of a class which is known as the instance of a class. So it has the same usage as the class.

Interface Notation:

Interface is represented by a circle as shown below. It has a name which is generally written below the circle.

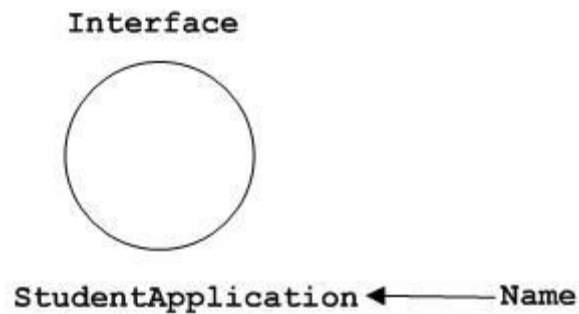

Interface is used to describe functionality without implementation. Interface is the just like a template where you define different functions not the implementation. When a class implements the interface it also implements the functionality as per the requirement.

Collaboration Notation:

Collaboration is represented by a dotted ellipse as shown below. It has a name written inside the ellipse.

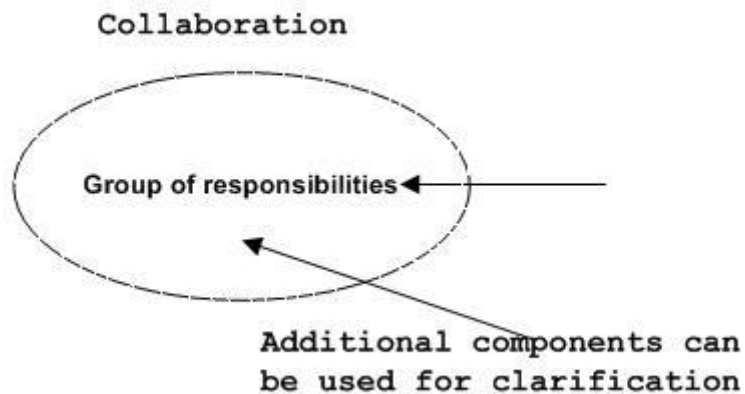

Collaboration represents responsibilities. Generally responsibilities are in a group.

Use case Notation:

Use case is represented as an ellipse with a name inside it. It may contain additional responsibilities.

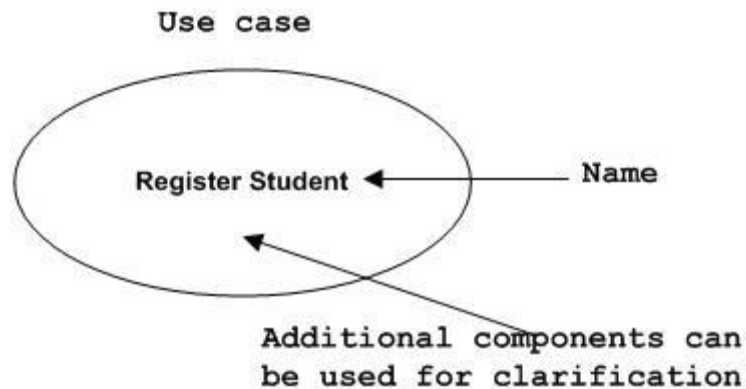

Use case is used to capture high level functionalities of a system.

Actor Notation:

An actor can be defined as some internal or external entity that interacts with the system.

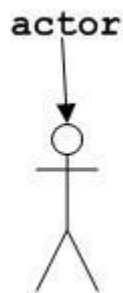

Actor is used in a use case diagram to describe the internal or external entities.

Initial State Notation:

Initial state is defined show the start of a process. This notation is used in almost all diagrams.

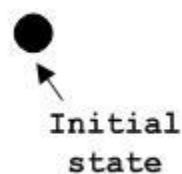

The usage of Initial State Notation is to show the starting point of a process.

Final State Notation:

Final state is used to show the end of a process. This notation is also used in almost all diagrams to describe the end.



The usage of Final State Notation is to show the termination point of a process.

Active class Notation:

Active class looks similar to a class with a solid border. Active class is generally used to describe concurrent behaviour of a system.

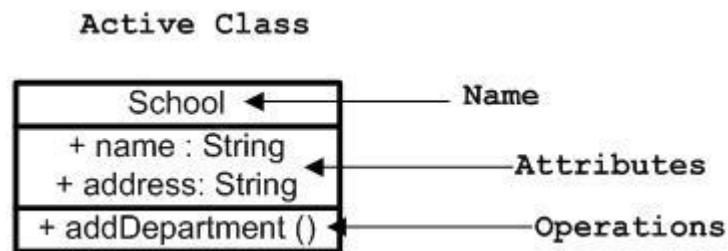

Active class is used to represent concurrency in a system.

Component Notation:

A component in UML is shown as below with a name inside. Additional elements can be added wherever required.

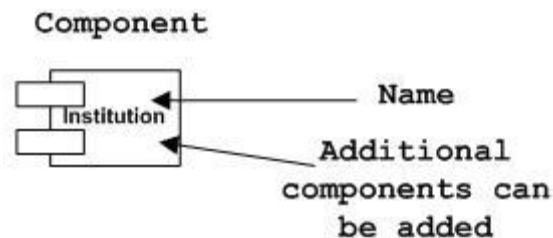

Component is used to represent any part of a system for which UML diagrams are made.

Node Notation:

A node in UML is represented by a square box as shown below with a name. A node represents a physical component of the system.

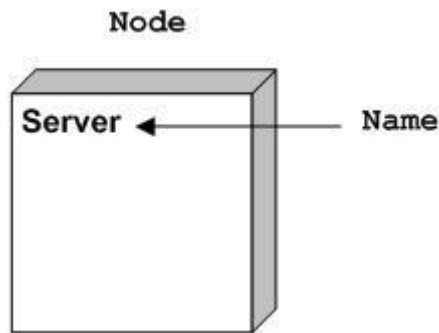

Node is used to represent physical part of a system like server, network etc.

Behavioural Things:

Dynamic parts are one of the most important elements in UML. UML has a set of powerful features to represent the dynamic part of software and non software systems. These features include *interactions* and *state machines*.

Interactions can be of two types:

- Sequential (Represented by sequence diagram)
- Collaborative (Represented by collaboration diagram)

Interaction Notation:

Interaction is basically message exchange between two UML components. The following diagram represents different notations used in an interaction.

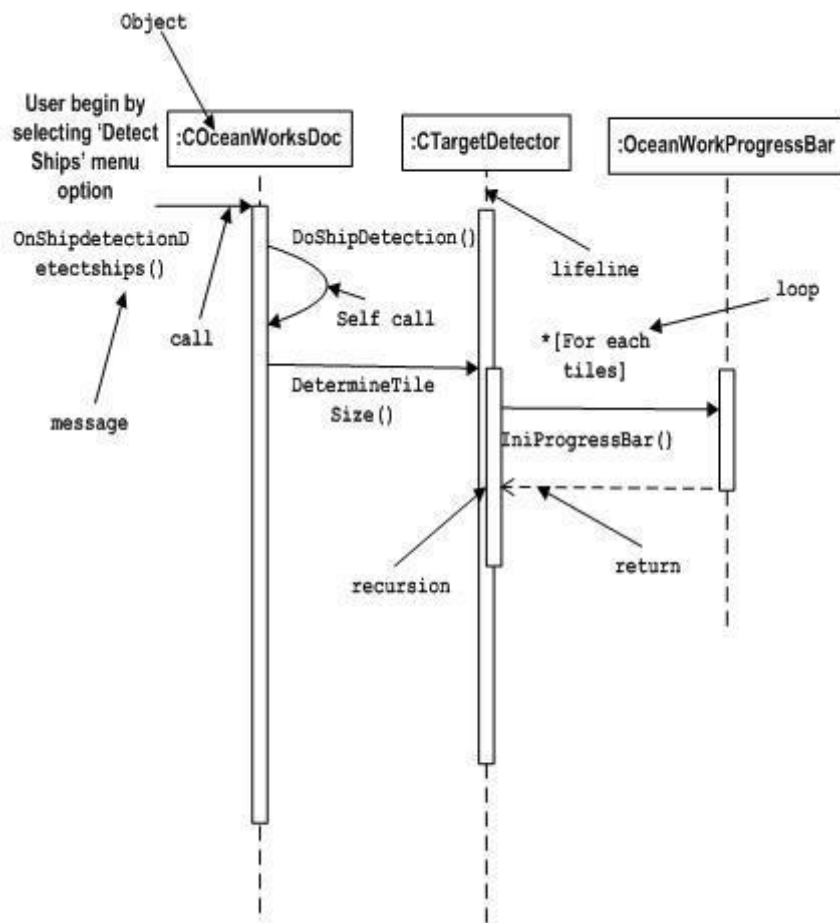

Interaction is used to represent communication among the components of a system.

State machine Notation:

State machine describes the different states of a component in its life cycle. The notations are described in the following diagram.

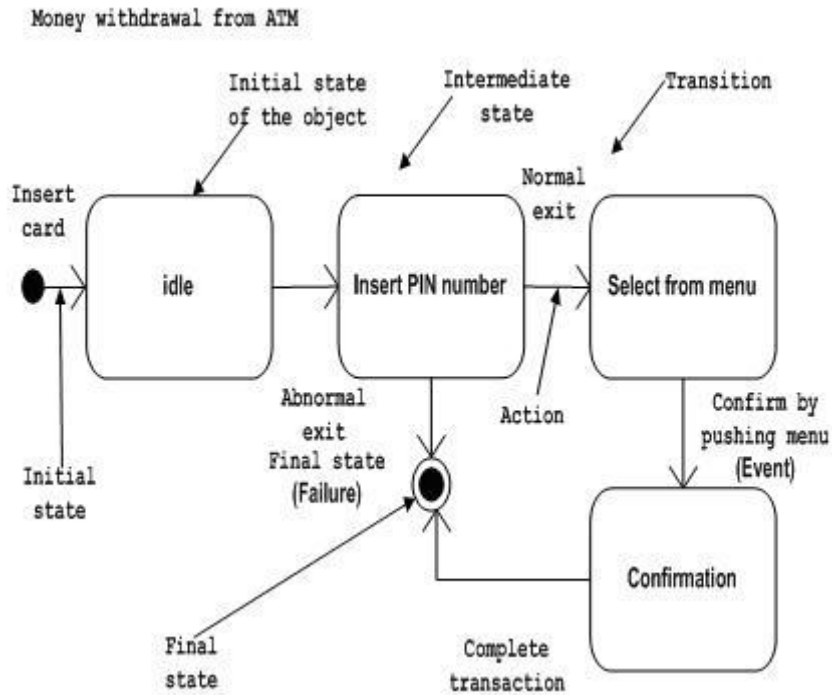

State machine is used to describe different states of a system component. The state can be active, idle or any other depending upon the situation.

Grouping Things:

Organizing the UML models are one of the most important aspects of the design. In UML there is only one element available for grouping and that is package.

Package Notation:

Package notation is shown below and this is used to wrap the components of a system.

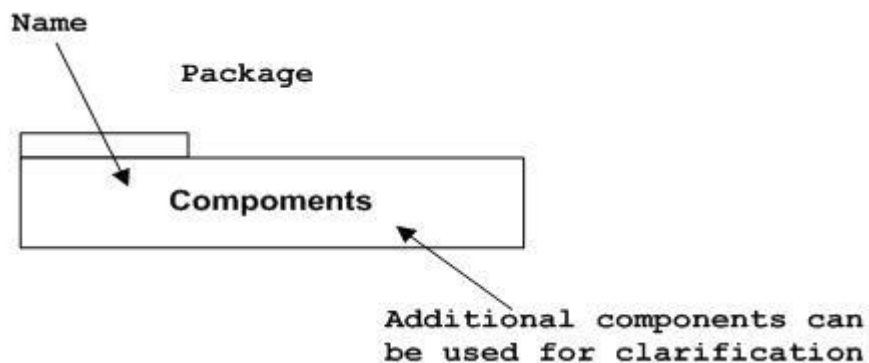

Annotational Things:

In any diagram explanation of different elements and their functionalities are very important. So UML has *notes* notation to support this requirement.

Note Notation:

This notation is shown below and they are used to provide necessary information of a system.

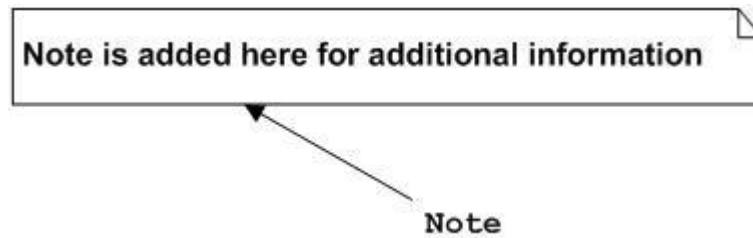

Relationships

A model is not complete unless the relationships between elements are described properly. The *Relationship* gives a proper meaning to an UML model. Following are the different types of relationships available in UML.

- Dependency
- Association
- Generalization
- Extensibility

Dependency Notation:

Dependency is an important aspect in UML elements. It describes the dependent elements and the direction of dependency.

Dependency is represented by a dotted arrow as shown below. The arrow head represents the independent element and the other end the dependent element.

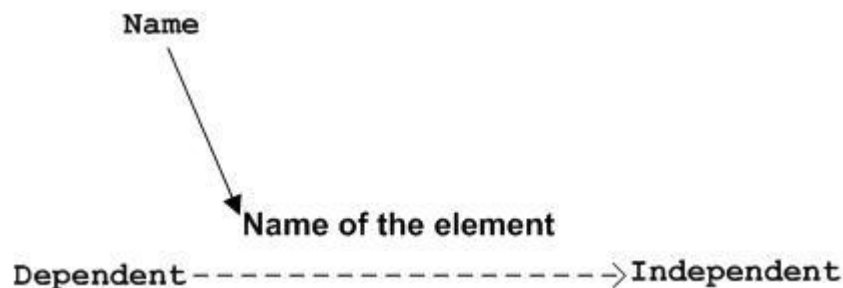

Dependency is used to represent dependency between two elements of a system.

Association Notation:

Association describes how the elements in an UML diagram are associated. In simple word it describes how many elements are taking part in an interaction.

Association is represented by a dotted line with (without) arrows on both sides. The two ends represent two associated elements as shown below. The multiplicity is also mentioned at the ends (1, * etc) to show how many objects are associated.

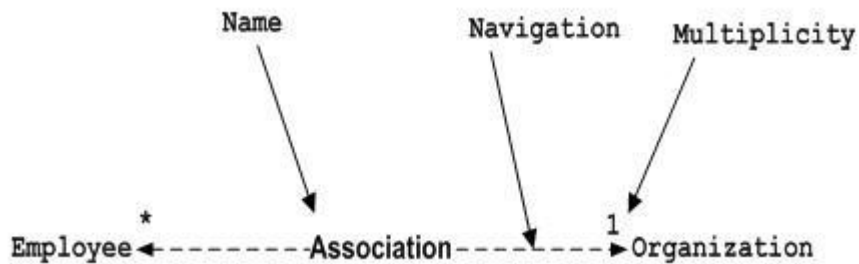

Association is used to represent the relationship between two elements of a system.

Generalization Notation:

Generalization describes the inheritance relationship of the object oriented world. It is parent and child relationship.

Generalization is represented by an arrow with hollow arrow head as shown below. One end represents the parent element and the other end child element.



Generalization is used to describe parent-child relationship of two elements of a system.

Extensibility Notation:

All the languages (programming or modelling) have some mechanism to extend its capabilities like syntax, semantics etc. UML is also having the following mechanisms to provide extensibility features.

- Stereotypes (Represents new elements)
- Tagged values (Represents new attributes)
- Constraints (Represents the boundaries)

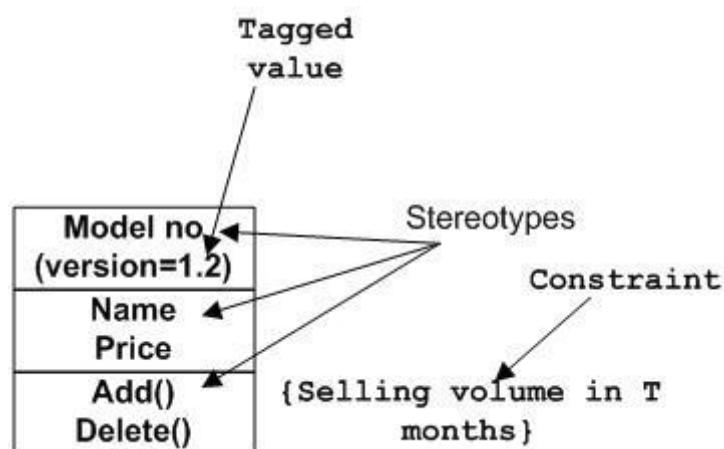

Extensibility notations are used to enhance the power of the language. It is basically additional elements used to represent some extra behaviour of the system. These extra behaviours are not covered by the standard available notations.

UML Standard Diagrams

In the previous chapters we have discussed about the building blocks and other necessary elements of UML. Now we need to understand where to use those elements.

The elements are like components which can be associated in different ways to make a complete UML pictures which is known as diagram. So it is very important to understand the different diagrams to implement the knowledge in real life systems.

Any complex system is best understood by making some kind of diagrams or pictures. These diagrams have a better impact on our understanding. So if we look around then we will realize that the diagrams are not a new concept but it is used widely in different form in different industries.

We prepare UML diagrams to understand a system in better and simple way. A single diagram is not enough to cover all aspects of the system. So UML defines various kinds of diagrams to cover most of the aspects of a system.

You can also create your own set of diagrams to meet your requirements. Diagrams are generally made in an incremental and iterative way.

There are two broad categories of diagrams and then are again divided into sub-categories:

- Structural Diagrams
- Behavioral Diagrams

Structural Diagrams:

The *structural diagrams* represent the static aspect of the system. These static aspects represent those parts of a diagram which forms the main structure and therefore stable.

These static parts are represented by classes, interfaces, objects, components and nodes. The four structural diagrams are:

- Class diagram
- Object diagram
- Component diagram
- Deployment diagram

Class Diagram:

Class diagrams are the most common diagrams used in UML. Class diagram consists of classes, interfaces, associations and collaboration.

Class diagrams basically represent the object oriented view of a system which is static in nature.

Active class is used in a class diagram to represent the concurrency of the system.

Class diagram represents the object orientation of a system. So it is generally used for development purpose. This is the most widely used diagram at the time of system construction.

Object Diagram:

Object diagrams can be described as an instance of class diagram. So these diagrams are more close to real life scenarios where we implement a system.

Object diagrams are a set of objects and their relationships just like class diagrams and also represent the static view of the system.

The usage of object diagrams is similar to class diagrams but they are used to build prototype of a system from practical perspective.

Component Diagram:

Component diagrams represent a set of components and their relationships. These components consist of classes, interfaces or collaborations.

So Component diagrams represent the implementation view of a system.

During design phase software artifacts (classes, interfaces etc) of a system are arranged in different groups depending upon their relationship. Now these groups are known as components.

Finally, component diagrams are used to visualize the implementation.

Deployment Diagram:

Deployment diagrams are a set of nodes and their relationships. These nodes are physical entities where the components are deployed.

Deployment diagrams are used for visualizing deployment view of a system. This is generally used by the deployment team.

Note: *If the above descriptions and usages are observed carefully then it is very clear that all the diagrams are having some relationship with one another. Component diagrams are dependent upon the classes, interfaces etc which are part of class/object diagram. Again the deployment diagram is dependent upon the components which are used to make a component diagrams.*

Behavioral Diagrams:

Any system can have two aspects, static and dynamic. So a model is considered as complete when both the aspects are covered fully.

Behavioral diagrams basically capture the dynamic aspect of a system. Dynamic aspect can be further described as the changing/moving parts of a system.

UML has the following five types of behavioral diagrams:

- Use case diagram
- Sequence diagram
- Collaboration diagram
- Statechart diagram
- Activity diagram

Use case Diagram:

Use case diagrams are a set of use cases, actors and their relationships. They represent the use case view of a system.

A use case represents a particular functionality of a system.

So use case diagram is used to describe the relationships among the functionalities and their internal/external controllers. These controllers are known as actors.

Sequence Diagram:

A sequence diagram is an interaction diagram. From the name it is clear that the diagram deals with some sequences, which are the sequence of messages flowing from one object to another.

Interaction among the components of a system is very important from implementation and execution perspective.

So Sequence diagram is used to visualize the sequence of calls in a system to perform a specific functionality.

Collaboration Diagram:

Collaboration diagram is another form of interaction diagram. It represents the structural organization of a system and the messages sent/received. Structural organization consists of objects and links.

The purpose of collaboration diagram is similar to sequence diagram. But the specific purpose of collaboration diagram is to visualize the organization of objects and their interaction.

Statechart Diagram:

Any real time system is expected to be reacted by some kind of internal/external events. These events are responsible for state change of the system.

Statechart diagram is used to represent the event driven state change of a system. It basically describes the state change of a class, interface etc.

State chart diagram is used to visualize the reaction of a system by internal/external factors.

Activity Diagram:

Activity diagram describes the flow of control in a system. So it consists of activities and links. The flow can be sequential, concurrent or branched.

Activities are nothing but the functions of a system. Numbers of activity diagrams are prepared to capture the entire flow in a system.

Activity diagrams are used to visualize the flow of controls in a system. This is prepared to have an idea of how the system will work when executed.

Note: *Dynamic nature of a system is very difficult to capture. So UML has provided features to capture the dynamics of a system from different angles. Sequence diagrams and collaboration diagrams are isomorphic so they can be converted from one another without losing any information. This is also true for statechart and activity diagram.*

UML Class Diagram

The class diagram is a static diagram. It represents the static view of an application. Class diagram is not only used for visualizing, describing and documenting different aspects of a system but also for constructing executable code of the software application.

The class diagram describes the attributes and operations of a class and also the constraints imposed on the system. The class diagrams are widely used in the modelling of object oriented systems because they are the only UML diagrams which can be mapped directly with object oriented languages.

The class diagram shows a collection of classes, interfaces, associations, collaborations and constraints. It is also known as a *structural diagram*.

Purpose:

The purpose of the class diagram is to model the static view of an application. The class diagrams are the only diagrams which can be directly mapped with object oriented languages and thus widely used at the time of construction.

The UML diagrams like activity diagram, sequence diagram can only give the sequence flow of the application but class diagram is a bit different. So it is the most popular UML diagram in the coder community.

So the purpose of the class diagram can be summarized as:

- Analysis and design of the static view of an application.
- Describe responsibilities of a system.
- Base for component and deployment diagrams.
- Forward and reverse engineering.

How to draw Class Diagram?

Class diagrams are the most popular UML diagrams used for construction of software applications. So it is very important to learn the drawing procedure of class diagram.

Class diagrams have lot of properties to consider while drawing but here the diagram will be considered from a top level view.

Class diagram is basically a graphical representation of the static view of the system and represents different aspects of the application. So a collection of class diagrams represent the whole system.

The following points should be remembered while drawing a class diagram:

- The name of the class diagram should be meaningful to describe the aspect of the system.
- Each element and their relationships should be identified in advance.
- Responsibility (attributes and methods) of each class should be clearly identified.
- For each class minimum number of properties should be specified. Because unnecessary properties will make the diagram complicated.
- Use notes when ever required to describe some aspect of the diagram. Because at the end of the drawing it should be understandable to the developer/coder.
- Finally, before making the final version, the diagram should be drawn on plain paper and rework as many times as possible to make it correct.

Now the following diagram is an example of an *Order System* of an application. So it describes a particular aspect of the entire application.

- First of all *Order* and *Customer* are identified as the two elements of the system and they have a *one to many* relationship because a customer can have multiple orders.
- We would keep *Order* class is an abstract class and it has two concrete classes (inheritance relationship) *SpecialOrder* and *NormalOrder*.

- The two inherited classes have all the properties as the *Order* class. In addition they have additional functions like *dispatch ()* and *receive ()*.

So the following class diagram has been drawn considering all the points mentioned above:

Sample Class Diagram

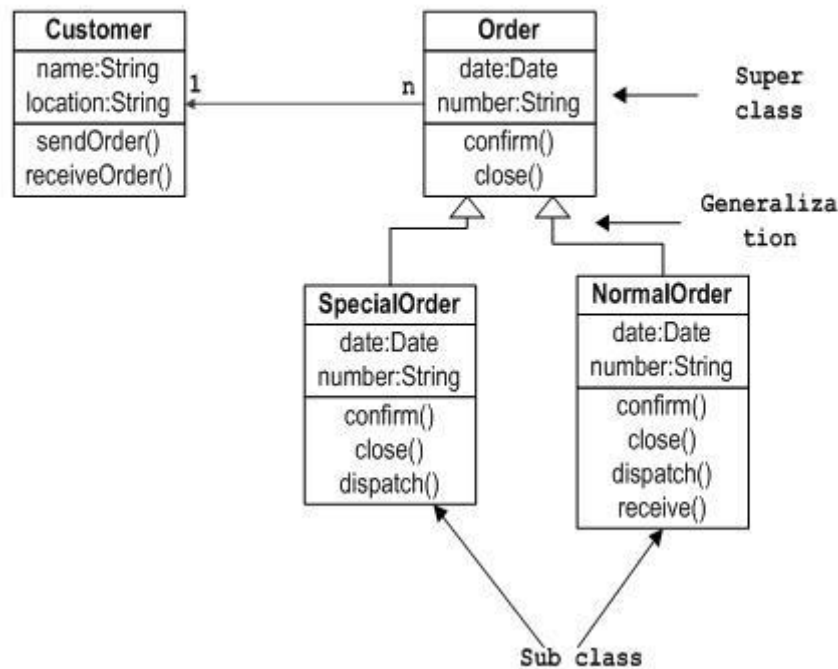

UML Object Diagram

Object diagrams are derived from class diagrams so object diagrams are dependent upon class diagrams.

Object diagrams represent an instance of a class diagram. The basic concepts are similar for class diagrams and object diagrams. Object diagrams also represent the static view of a system but this static view is a snapshot of the system at a particular moment.

Object diagrams are used to render a set of objects and their relationships as an instance.

Purpose:

The purpose of a diagram should be understood clearly to implement it practically. The purposes of object diagrams are similar to class diagrams.

The difference is that a class diagram represents an abstract model consists of classes and their relationships. But an object diagram represents an instance at a particular moment which is concrete in nature.

It means the object diagram is more close to the actual system behaviour. The purpose is to capture the static view of a system at a particular moment.

So the purpose of the object diagram can be summarized as:

- Forward and reverse engineering.
- Object relationships of a system

- Static view of an interaction.
- Understand object behaviour and their relationship from practical perspective

How to draw Object Diagram?

We have already discussed that an object diagram is an instance of a class diagram. It implies that an object diagram consists of instances of things used in a class diagram.

So both diagrams are made of same basic elements but in different form. In class diagram elements are in abstract form to represent the blue print and in object diagram the elements are in concrete form to represent the real world object.

To capture a particular system, numbers of class diagrams are limited. But if we consider object diagrams then we can have unlimited number of instances which are unique in nature. So only those instances are considered which are having impact on the system.

From the above discussion it is clear that a single object diagram cannot capture all the necessary instances or rather cannot specify all objects of a system. So the solution is:

- First, analyze the system and decide which instances are having important data and association.
- Second, consider only those instances which will cover the functionality.
- Third, make some optimization as the numbers of instances are unlimited.

Before drawing an object diagrams the following things should be remembered and understood clearly:

- Object diagrams are consist of objects.
- The link in object diagram is used to connect objects.
- Objects and links are the two elements used to construct an object diagram.

Now after this the following things are to be decided before starting the construction of the diagram:

- The object diagram should have a meaningful name to indicate its purpose.
- The most important elements are to be identified.
- The association among objects should be clarified.
- Values of different elements need to be captured to include in the object diagram.
- Add proper notes at points where more clarity is required.

The following diagram is an example of an object diagram. It represents the *Order management system* which we have discussed in *Class Diagram*. The following diagram is an instance of the system at a particular time of purchase. It has the following objects

- Customer
- Order
- SpecialOrder
- NormalOrder

Now the customer object (C) is associated with three order objects (O1, O2 and O3). These order objects are associated with special order and normal order objects (S1, S2 and N1). The customer is having the following three orders with different numbers (12, 32 and 40) for the particular time considered.

Now the customer can increase number of orders in future and in that scenario the object diagram will reflect that. If order, special order and normal order objects are observed then we you will find that they are having some values.

For orders the values are 12, 32, and 40 which implies that the objects are having these values for the particular moment (here the particular time when the purchase is made is considered as the moment) when the instance is captured.

The same is for special order and normal order objects which are having number of orders as 20, 30 and 60. If a different time of purchase is considered then these values will change accordingly.

So the following object diagram has been drawn considering all the points mentioned above:

Object diagram of an order management system

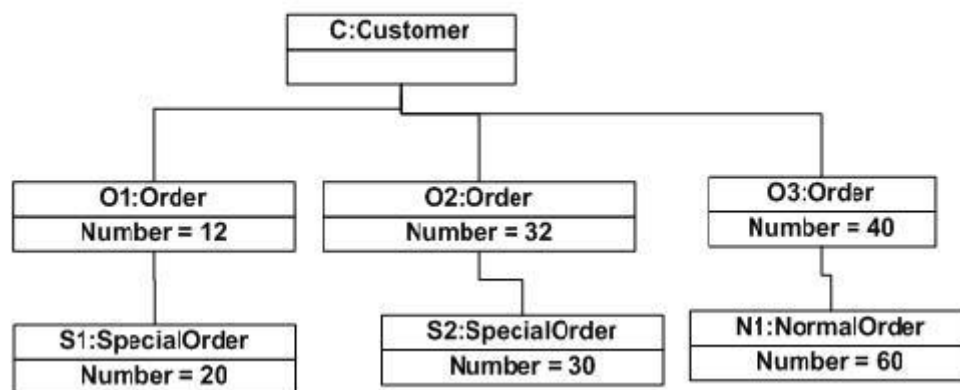

UML Component Diagram

Component diagrams are different in terms of nature and behaviour. Component diagrams are used to model physical aspects of a system.

Now the question is what are these physical aspects? Physical aspects are the elements like executables, libraries, files, documents etc which resides in a node.

So component diagrams are used to visualize the organization and relationships among components in a system. These diagrams are also used to make executable systems.

Purpose:

Component diagram is a special kind of diagram in UML. The purpose is also different from all other diagrams discussed so far. It does not describe the functionality of the system but it describes the components used to make those functionalities.

So from that point component diagrams are used to visualize the physical components in a system. These components are libraries, packages, files etc.

Component diagrams can also be described as a static implementation view of a system. Static implementation represents the organization of the components at a particular moment.

A single component diagram cannot represent the entire system but a collection of diagrams are used to represent the whole.

So the purpose of the component diagram can be summarized as:

- Visualize the components of a system.
- Construct executables by using forward and reverse engineering.
- Describe the organization and relationships of the components.

How to draw Component Diagram?

Component diagrams are used to describe the physical artifacts of a system. This artifact includes files, executables, libraries etc.

So the purpose of this diagram is different, Component diagrams are used during the implementation phase of an application. But it is prepared well in advance to visualize the implementation details.

Initially the system is designed using different UML diagrams and then when the artifacts are ready component diagrams are used to get an idea of the implementation.

This diagram is very important because without it the application cannot be implemented efficiently. A well prepared component diagram is also important for other aspects like application performance, maintenance etc.

So before drawing a component diagram the following artifacts are to be identified clearly:

- Files used in the system.
- Libraries and other artifacts relevant to the application.
- Relationships among the artifacts.

Now after identifying the artifacts the following points needs to be followed:

- Use a meaningful name to identify the component for which the diagram is to be drawn.
- Prepare a mental layout before producing using tools.
- Use notes for clarifying important points.

The following is a component diagram for order management system. Here the artifacts are files. So the diagram shows the files in the application and their relationships. In actual the component diagram also contains dlls, libraries, folders etc.

In the following diagram four files are identified and their relationships are produced. Component diagram cannot be matched directly with other UML diagrams discussed so far. Because it is drawn for completely different purpose.

So the following component diagram has been drawn considering all the points mentioned above:

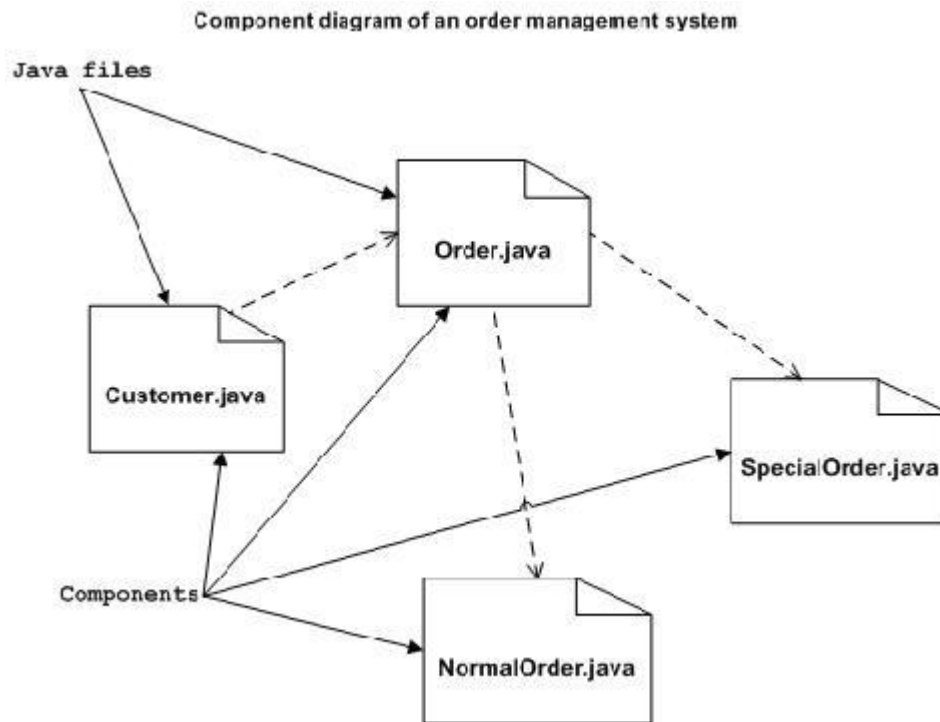

UML Deployment Diagram

Deployment diagrams are used to visualize the topology of the physical components of a system where the software components are deployed.

So deployment diagrams are used to describe the static deployment view of a system. Deployment diagrams consist of nodes and their relationships.

Purpose:

The name *Deployment* itself describes the purpose of the diagram. Deployment diagrams are used for describing the hardware components where software components are deployed. Component diagrams and deployment diagrams are closely related.

Component diagrams are used to describe the components and deployment diagrams shows how they are deployed in hardware.

UML is mainly designed to focus on software artifacts of a system. But these two diagrams are special diagrams used to focus on software components and hardware components.

So most of the UML diagrams are used to handle logical components but deployment diagrams are made to focus on hardware topology of a system. Deployment diagrams are used by the system engineers.

The purpose of deployment diagrams can be described as:

- Visualize hardware topology of a system.
- Describe the hardware components used to deploy software components.
- Describe runtime processing nodes.

How to draw Deployment Diagram?

Deployment diagram represents the deployment view of a system. It is related to the component diagram. Because the components are deployed using the deployment diagrams. A deployment diagram consists of nodes. Nodes are nothing but physical hardwares used to deploy the application.

Deployment diagrams are useful for system engineers. An efficient deployment diagram is very important because it controls the following parameters

- Performance
- Scalability
- Maintainability
- Portability

So before drawing a deployment diagram the following artifacts should be identified:

- Nodes
- Relationships among nodes

The following deployment diagram is a sample to give an idea of the deployment view of order management system. Here we have shown nodes as:

- Monitor
- Modem
- Caching server
- Server

The application is assumed to be a web based application which is deployed in a clustered environment using server 1, server 2 and server 3. The user is connecting to the application using internet. The control is flowing from the caching server to the clustered environment.

So the following deployment diagram has been drawn considering all the points mentioned above:

Deployment diagram of an order management system

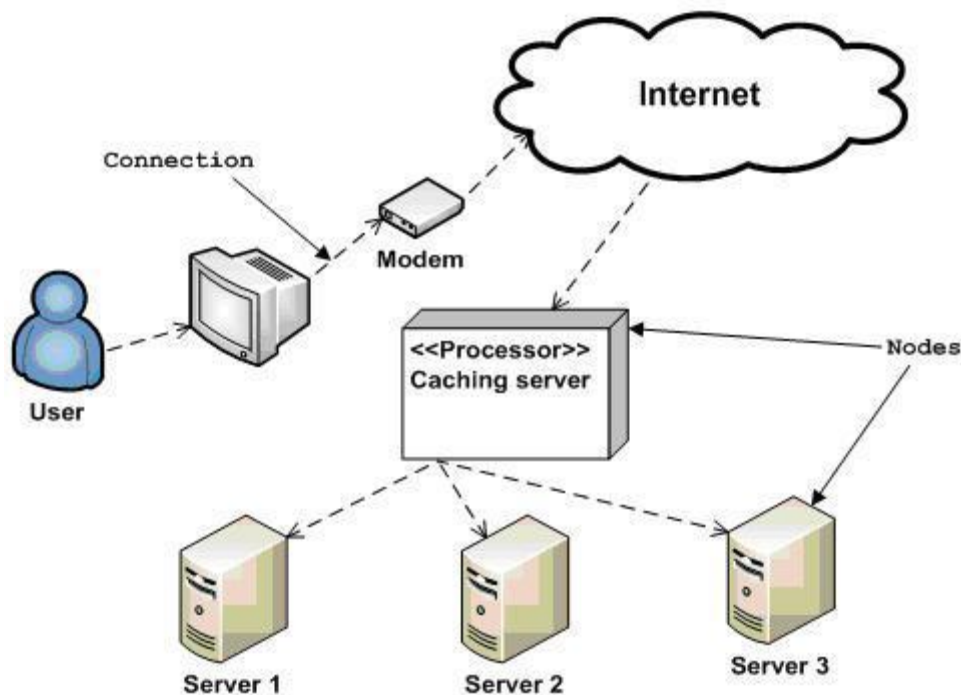

UML Use Case Diagram

To model a system the most important aspect is to capture the dynamic behaviour. To clarify a bit in details, *dynamic behaviour* means the behaviour of the system when it is running /operating.

So only static behaviour is not sufficient to model a system rather dynamic behaviour is more important than static behaviour. In UML there are five diagrams available to model dynamic nature and use case diagram is one of them. Now as we have to discuss that the use case diagram is dynamic in nature there should be some internal or external factors for making the interaction.

These internal and external agents are known as actors. So use case diagrams are consists of actors, use cases and their relationships. The diagram is used to model the system/subsystem of an application. A single use case diagram captures a particular functionality of a system.

So to model the entire system numbers of use case diagrams are used.

Purpose:

The purpose of use case diagram is to capture the dynamic aspect of a system. But this definition is too generic to describe the purpose.

Because other four diagrams (activity, sequence, collaboration and Statechart) are also having the same purpose. So we will look into some specific purpose which will distinguish it from other four diagrams.

Use case diagrams are used to gather the requirements of a system including internal and external influences. These requirements are mostly design requirements. So when a system is analyzed to gather its functionalities use cases are prepared and actors are identified.

Now when the initial task is complete use case diagrams are modelled to present the outside view.

So in brief, the purposes of use case diagrams can be as follows:

- Used to gather requirements of a system.
- Used to get an outside view of a system.
- Identify external and internal factors influencing the system.
- Show the interacting among the requirements are actors.

How to draw Use Case Diagram?

Use case diagrams are considered for high level requirement analysis of a system. So when the requirements of a system are analyzed the functionalities are captured in use cases.

So we can say that uses cases are nothing but the system functionalities written in an organized manner. Now the second things which are relevant to the use cases are the actors. Actors can be defined as something that interacts with the system.

The actors can be human user, some internal applications or may be some external applications. So in a brief when we are planning to draw an use case diagram we should have the following items identified.

- Functionalities to be represented as an use case
- Actors
- Relationships among the use cases and actors.

Use case diagrams are drawn to capture the functional requirements of a system. So after identifying the above items we have to follow the following guidelines to draw an efficient use case diagram.

- The name of a use case is very important. So the name should be chosen in such a way so that it can identify the functionalities performed.
- Give a suitable name for actors.
- Show relationships and dependencies clearly in the diagram.
- Do not try to include all types of relationships. Because the main purpose of the diagram is to identify requirements.
- Use note when ever required to clarify some important points.

The following is a sample use case diagram representing the order management system. So if we look into the diagram then we will find three use cases (*Order*, *SpecialOrder* and *NormalOrder*) and one actor which is *customer*.

The *SpecialOrder* and *NormalOrder* use cases are extended from *Order* use case. So they have extends relationship. Another important point is to identify the system boundary which is shown in the picture. The actor *Customer* lies outside the system as it is an external user of the system.

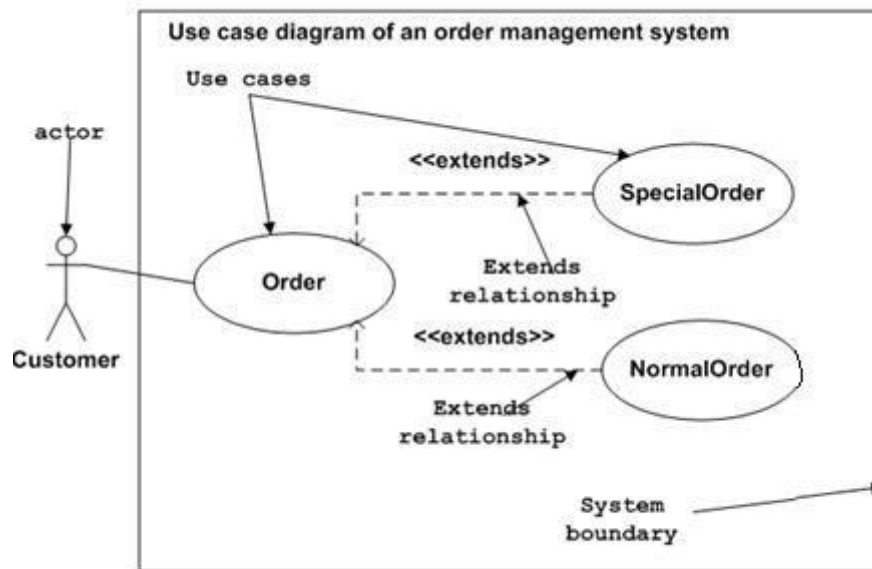

Figure: Sample Use Case diagram

UML Interaction Diagram

From the name *Interaction* it is clear that the diagram is used to describe some type of interactions among the different elements in the model. So this interaction is a part of dynamic behaviour of the system.

This interactive behaviour is represented in UML by two diagrams known as *Sequence diagram* and *Collaboration diagram*. The basic purposes of both the diagrams are similar.

Sequence diagram emphasizes on time sequence of messages and collaboration diagram emphasizes on the structural organization of the objects that send and receive messages.

Purpose:

The purposes of interaction diagrams are to visualize the interactive behaviour of the system. Now visualizing interaction is a difficult task. So the solution is to use different types of models to capture the different aspects of the interaction.

That is why sequence and collaboration diagrams are used to capture dynamic nature but from a different angle.

So the purposes of interaction diagram can be describes as:

- To capture dynamic behaviour of a system.
- To describe the message flow in the system.
- To describe structural organization of the objects.
- To describe interaction among objects.

How to draw Interaction Diagram?

As we have already discussed that the purpose of interaction diagrams are to capture the dynamic aspect of a system. So to capture the dynamic aspect we need to understand what a dynamic aspect is and how it is visualized. Dynamic aspect can be defined as the snap shot of the running system at a particular moment.

We have two types of interaction diagrams in UML. One is sequence diagram and the other is a collaboration diagram. The sequence diagram captures the time sequence of message flow from one object to another and the collaboration diagram describes the organization of objects in a system taking part in the message flow.

So the following things are to identified clearly before drawing the interaction diagram:

- Objects taking part in the interaction.
- Message flows among the objects.
- The sequence in which the messages are flowing.
- Object organization.

Following are two interaction diagrams modelling order management system. The first diagram is a sequence diagram and the second is a collaboration diagram.

The Sequence Diagram:

The sequence diagram is having four objects (Customer, Order, SpecialOrder and NormalOrder).

The following diagram has shown the message sequence for *SpecialOrder* object and the same can be used in case of *NormalOrder* object. Now it is important to understand the time sequence of message flows. The message flow is nothing but a method call of an object.

The first call is *sendOrder ()* which is a method of *Order* object. The next call is *confirm ()* which is a method of *SpecialOrder* object and the last call is *Dispatch ()* which is a method of *SpecialOrder* object. So here the diagram is mainly describing the method calls from one object to another and this is also the actual scenario when the system is running.

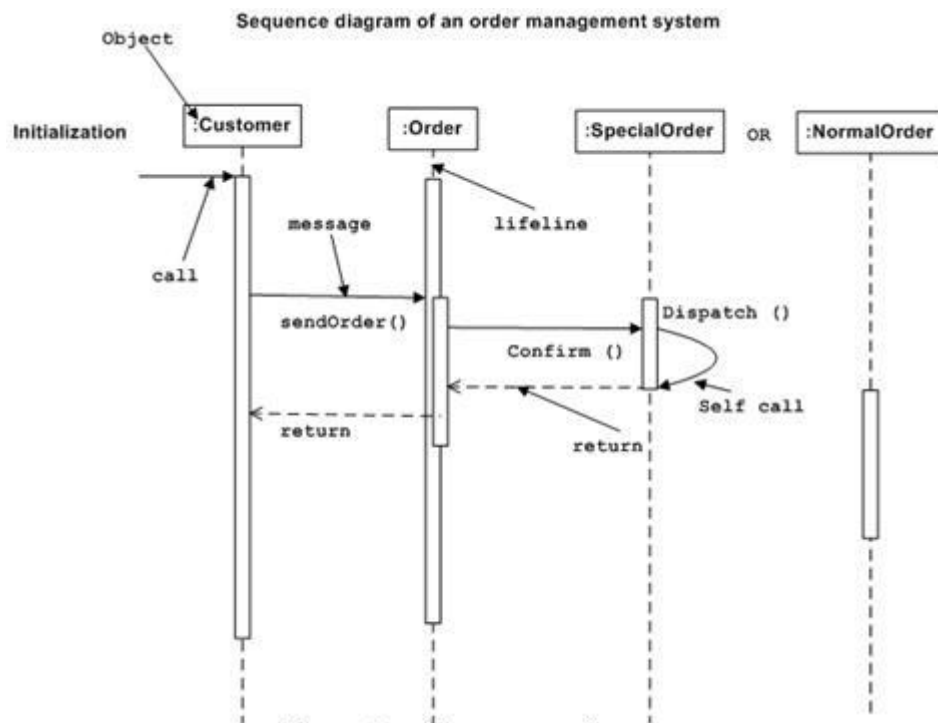

The Collaboration Diagram:

The second interaction diagram is collaboration diagram. It shows the object organization as shown below. Here in collaboration diagram the method call sequence is indicated by some numbering technique as shown below. The number indicates how the methods are called one

after another. We have taken the same order management system to describe the collaboration diagram.

The method calls are similar to that of a sequence diagram. But the difference is that the sequence diagram does not describe the object organization where as the collaboration diagram shows the object organization.

Now to choose between these two diagrams the main emphasis is given on the type of requirement. If the time sequence is important then sequence diagram is used and if organization is required then collaboration diagram is used.

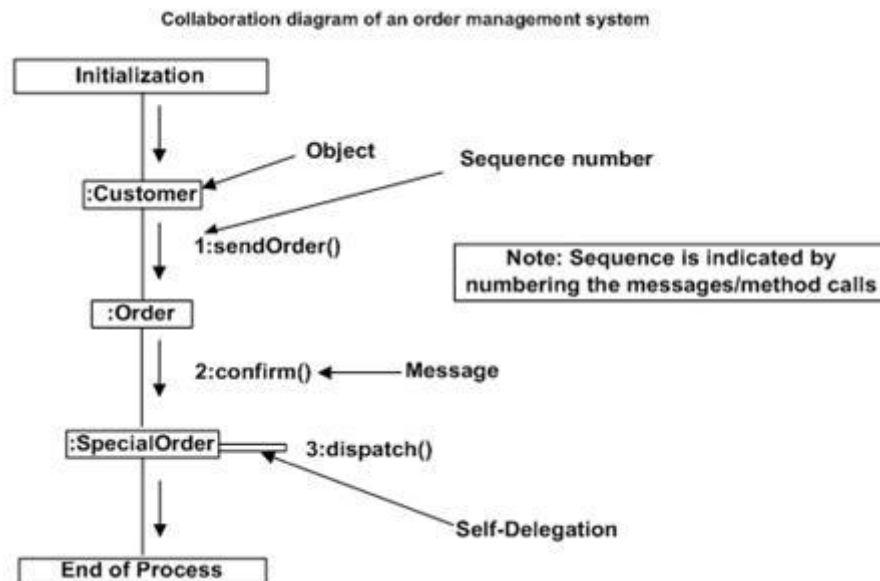

UML Statechart Diagram

The name of the diagram itself clarifies the purpose of the diagram and other details. It describes different states of a component in a system. The states are specific to a component/object of a system.

A Statechart diagram describes a state machine. Now to clarify it state machine can be defined as a machine which defines different states of an object and these states are controlled by external or internal events.

Activity diagram explained in next chapter, is a special kind of a Statechart diagram. As Statechart diagram defines states it is used to model lifetime of an object.

Purpose:

Statechart diagram is one of the five UML diagrams used to model dynamic nature of a system. They define different states of an object during its lifetime. And these states are changed by events. So Statechart diagrams are useful to model reactive systems. Reactive systems can be defined as a system that responds to external or internal events.

Statechart diagram describes the flow of control from one state to another state. States are defined as a condition in which an object exists and it changes when some event is triggered. So the most important purpose of Statechart diagram is to model life time of an object from creation to termination.

Statechart diagrams are also used for forward and reverse engineering of a system. But the main purpose is to model reactive system.

Following are the main purposes of using Statechart diagrams:

- To model dynamic aspect of a system.
- To model life time of a reactive system.
- To describe different states of an object during its life time.
- Define a state machine to model states of an object.

How to draw Statechart Diagram?

Statechart diagram is used to describe the states of different objects in its life cycle. So the emphasis is given on the state changes upon some internal or external events. These states of objects are important to analyze and implement them accurately.

Statechart diagrams are very important for describing the states. States can be identified as the condition of objects when a particular event occurs.

Before drawing a Statechart diagram we must have clarified the following points:

- Identify important objects to be analyzed.
- Identify the states.
- Identify the events.

The following is an example of a Statechart diagram where the state of *Order* object is analyzed.

The first state is an idle state from where the process starts. The next states are arrived for events like *send request*, *confirm request*, and *dispatch order*. These events are responsible for state changes of order object.

During the life cycle of an object (here order object) it goes through the following states and there may be some abnormal exists also. This abnormal exit may occur due to some problem in the system. When the entire life cycle is complete it is considered as the complete transaction as mentioned below.

The initial and final state of an object is also shown below.

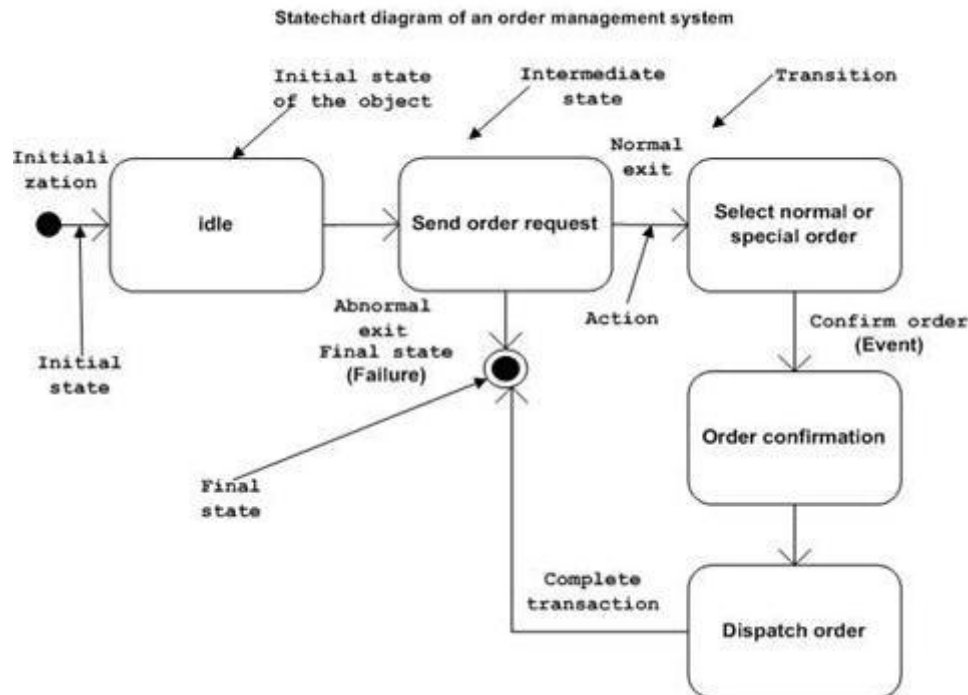

UML Activity Diagram

Activity diagram is another important diagram in UML to describe dynamic aspects of the system.

Activity diagram is basically a flow chart to represent the flow from one activity to another activity. The activity can be described as an operation of the system.

So the control flow is drawn from one operation to another. This flow can be sequential, branched or concurrent. Activity diagrams deal with all types of flow control by using different elements like fork, join etc.

Purpose:

The basic purposes of activity diagrams are similar to other four diagrams. It captures the dynamic behaviour of the system. Other four diagrams are used to show the message flow from one object to another but activity diagram is used to show message flow from one activity to another.

Activity is a particular operation of the system. Activity diagrams are not only used for visualizing dynamic nature of a system but they are also used to construct the executable system by using forward and reverse engineering techniques. The only missing thing in activity diagram is the message part.

It does not show any message flow from one activity to another. Activity diagram is sometimes considered as the flow chart. Although the diagram looks like a flow chart but it is not. It shows different flows like parallel, branched, concurrent and single.

So the purposes can be described as:

- Draw the activity flow of a system.
- Describe the sequence from one activity to another.
- Describe the parallel, branched and concurrent flow of the system.

How to draw Activity Diagram?

Activity diagrams are mainly used as a flow chart consists of activities performed by the system. But activity diagram are not exactly a flow chart as they have some additional capabilities. These additional capabilities include branching, parallel flow, swimlane etc.

Before drawing an activity diagram we must have a clear understanding about the elements used in activity diagram. The main element of an activity diagram is the activity itself. An activity is a function performed by the system. After identifying the activities we need to understand how they are associated with constraints and conditions.

So before drawing an activity diagram we should identify the following elements:

- Activities
- Association
- Conditions
- Constraints

Once the above mentioned parameters are identified we need to make a mental layout of the entire flow. This mental layout is then transformed into an activity diagram.

The following is an example of an activity diagram for order management system. In the diagram four activities are identified which are associated with conditions. One important point should be clearly understood that an activity diagram cannot be exactly matched with the code. The activity diagram is made to understand the flow of activities and mainly used by the business users.

The following diagram is drawn with the four main activities:

- Send order by the customer
- Receipt of the order
- Confirm order
- Dispatch order

After receiving the order request condition checks are performed to check if it is normal or special order. After the type of order is identified dispatch activity is performed and that is marked as the termination of the process.

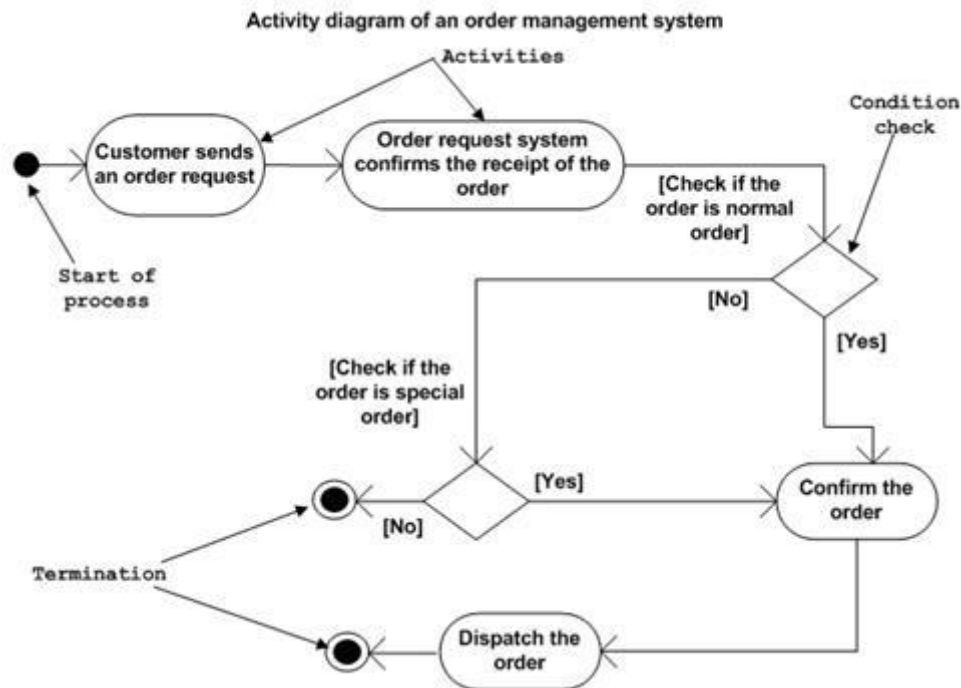

Further Detail:

Refer to the link <http://www.tutorialspoint.com/uml>

List of Tutorials from **TutorialsPoint.com**

- | | |
|---|---|
| <ul style="list-style-type: none"> ▪ Learn JSP ▪ Learn Servlets ▪ Learn log4j ▪ Learn iBATIS ▪ Learn Java ▪ Learn JDBC ▪ Java Examples ▪ Learn Best Practices ▪ Learn Python ▪ Learn Ruby ▪ Learn Ruby on Rails ▪ Learn SQL ▪ Learn MySQL ▪ Learn AJAX ▪ Learn C Programming ▪ Learn C++ Programming ▪ Learn CGI with PERL ▪ Learn DLL ▪ Learn ebXML | <ul style="list-style-type: none"> ▪ Learn ASP.Net ▪ Learn HTML ▪ Learn HTML5 ▪ Learn XHTML ▪ Learn CSS ▪ Learn HTTP ▪ Learn JavaScript ▪ Learn jQuery ▪ Learn Prototype ▪ Learn script.aculo.us ▪ Web Developer's Guide ▪ Learn RADIUS ▪ Learn RSS ▪ Learn SEO Techniques ▪ Learn SOAP ▪ Learn UDDI ▪ Learn Unix Sockets ▪ Learn Web Services ▪ Learn XML-RPC |
|---|---|



Tutorials Point, Simply Easy Learning

- | | |
|---|---|
| <ul style="list-style-type: none">▪ Learn Euphoria▪ Learn GDB Debugger▪ Learn Makefile▪ Learn Parrot▪ Learn Perl Script▪ Learn PHP Script▪ Learn Six Sigma▪ Learn SEI CMMI▪ Learn WiMAX▪ Learn Telecom Billing | <ul style="list-style-type: none">▪ Learn UML▪ Learn UNIX▪ Learn WSDL▪ Learn i-Mode▪ Learn GPRS▪ Learn GSM▪ Learn WAP▪ Learn WML▪ Learn Wi-Fi |
|---|---|

webmaster@TutorialsPoint.com