

CNE301 – Network I – Lab 05

Building a straight
through cable and
configuring a star
network.

#	Student ID	Student Name	Grade (10)
1			

Connecting a simple star Ethernet network







build Straight-Through Cable

Objective

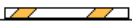
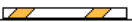









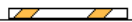



- Build a Category 5 or Category 5e Unshielded Twisted Pair (UTP) Ethernet network patch cable or patch cord.
- Test the cable for continuity and correct pinouts, the correct color of wire on the right pin.
- Build simple start network consists of 3 PCs and a Hub.
- Test logical connection between these PCs using ping, ipconfig and tracert commands.

Background

- use only two pairs to build straight through Ethernet cable as shown

RJ45 Pin # (END 1)	Function	Wire Color	Diagram End #1	RJ45 Pin # (END 2)	Function	Wire Color	Diagram End #2
1	Tx+	White/Orange		1	Tx+	White/Orange	
2	Tx-	Orange		2	Tx-	Orange	
3	Rx+	White/Green		3	Rx+	White/Green	
6	Rx-	Green		6	Rx-	Green	

- Using four pairs to build straight through Ethernet cable as shown

RJ45 Pin # (END 1)	Function	Wire Color	Diagram End #1	RJ45 Pin # (END 2)	Function	Wire Color	Diagram End #2
1	Tx+	White/Orange		1	Tx+	White/Orange	
2	Tx-	Orange		2	Tx-	Orange	
3	Rx+	White/Green		3	Rx+	White/Green	
4	X	Blue		4	X	Blue	
5	X	White/Blue		5	X	White/Blue	
6	Rx-	Green		6	Rx-	Green	
7	X	White/Brown		7	X	White/Brown	
8	X	Brown		8	X	Brown	

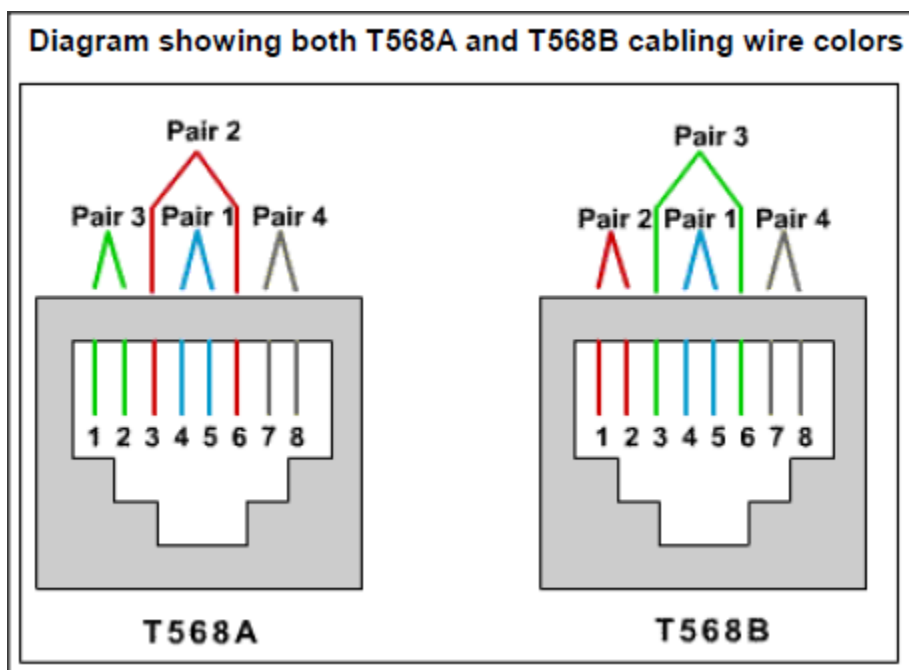

Use the preceding table and diagram to create a T568B patch panel cable. Both cable ends should be wired the same when looking at the conductors.

Tools and components

Components

1. Cable - Be sure the cable(s) you are using is properly rated for CAT 5.



2. Connectors – Ethernet cables are terminated with CAT 5 RJ-45 (RJ stands for "Registered Jack") modular plugs.

RJ-45 plugs are similar to those you'll see on the end of your telephone cable except they have eight versus four contacts on the end of the plug.

3. RJ-45 Crimping tool

Used to connect RJ45 connectors to Cat5 cables.



Steps

1. Step 1, Build two cables

Step 1

Determine the distance between devices or device and plug. Add at least 30.48 cm (12 in.) to the distance.

Step 2

Cut a piece of stranded Category UTP cable to the desired length. Use stranded cable for patch cables because it is more durable when bent repeatedly. Solid wire is used cable runs that are punched down into jacks.

Step 3

Strip 5.08 cm (2 in.) of jacket off of one end of the cable.

Step 4

Hold the four pairs of twisted cables tightly where jacket was cut away. Reorganize the cable pairs into the order of the T568B wiring standard. Take care to maintain as much of the twists as possible since this provides noise cancellation.

Step 5

Hold the jacket and cable in one hand and untwist a short length of the green and blue pairs. Reorder the pairs to reflect the T568B wiring color scheme. Untwist and order the rest of the wire pairs according to the color scheme.

Step 6

Flatten, straighten, and line up the wires. Trim them in a straight line to within 1.25 to 1.9 cm (1/2 to 3/4 in.) from the edge of the jacket. Be sure not to let go of the jacket and the wires, which are

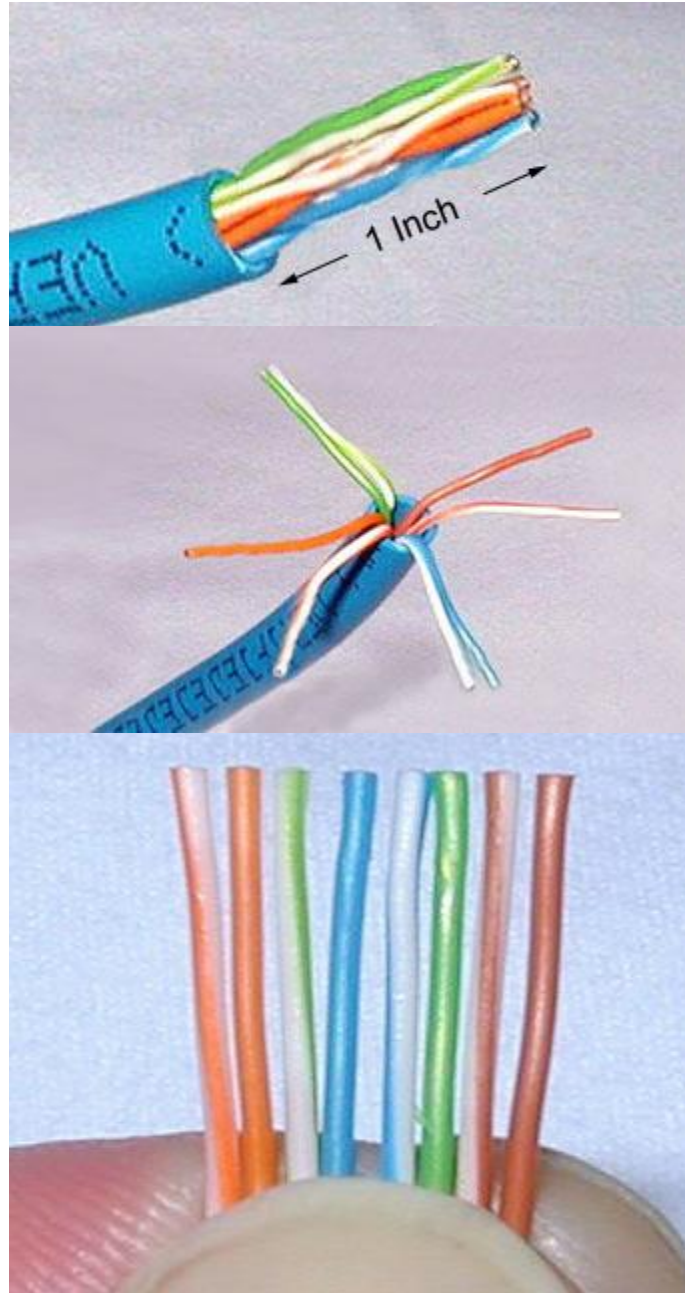

for



now in the proper order. Minimize the length of untwisted wires because sections that are too long and near connectors are a primary source of electrical noise.

Step 7

Place an RJ-45 plug on the end of the cable, with the prong on the underside and the orange pair to the left side of the connector.

Step 8

Gently push the plug onto wires until the copper ends of the wires can be seen through the end of the plug. Make sure the end of the jacket is inside the plug. This provides for stress relief and to ensure that all wires are in the correct order.

If the jacket is not inside the plug, the plug will not be properly gripped and will eventually cause problems. If everything is correct, crimp the plug hard enough to force the contacts through the insulation on the wires, completing the conducting path.

Step 9

Repeat Steps 3 through 8 to terminate the other end of the cable. Use the same scheme to finish the straight through cable.

Step 10

Test the finished cable. Have the instructor check the finished cable. How is it possible to tell if the cable is functioning properly?

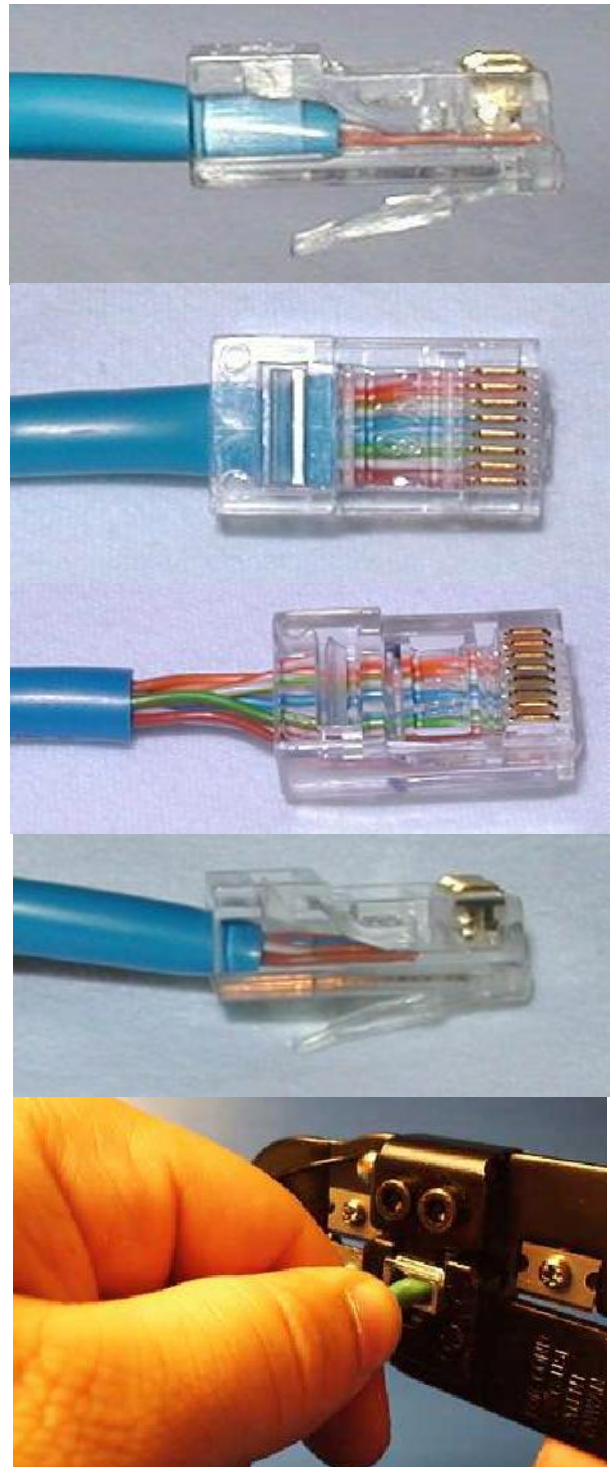



Step 2, establish the physical connection

Connect 3 PCs and hub as shown in figure

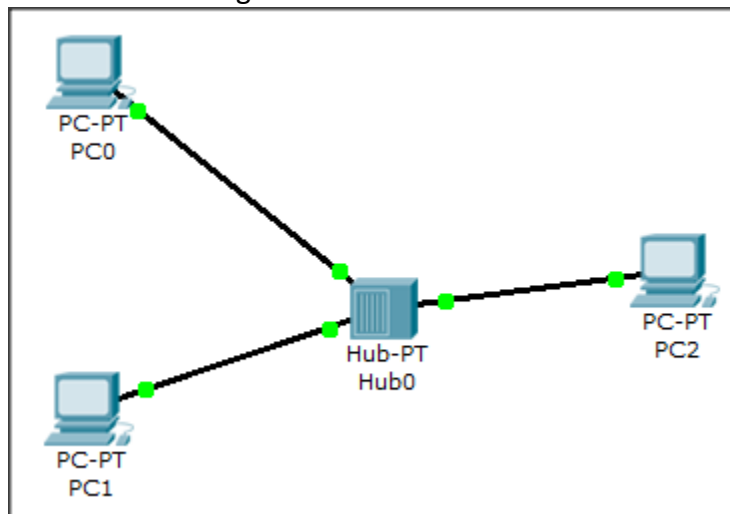

Step 3, configure windows network settings

Be sure to write down the existing IP settings, so that they can be restored at the end of the lab. These include IP address, subnet mask, default gateway, and DNS servers. If the workstation is a DHCP client, it is not necessary to record this information.

Windows XP users should do the following:

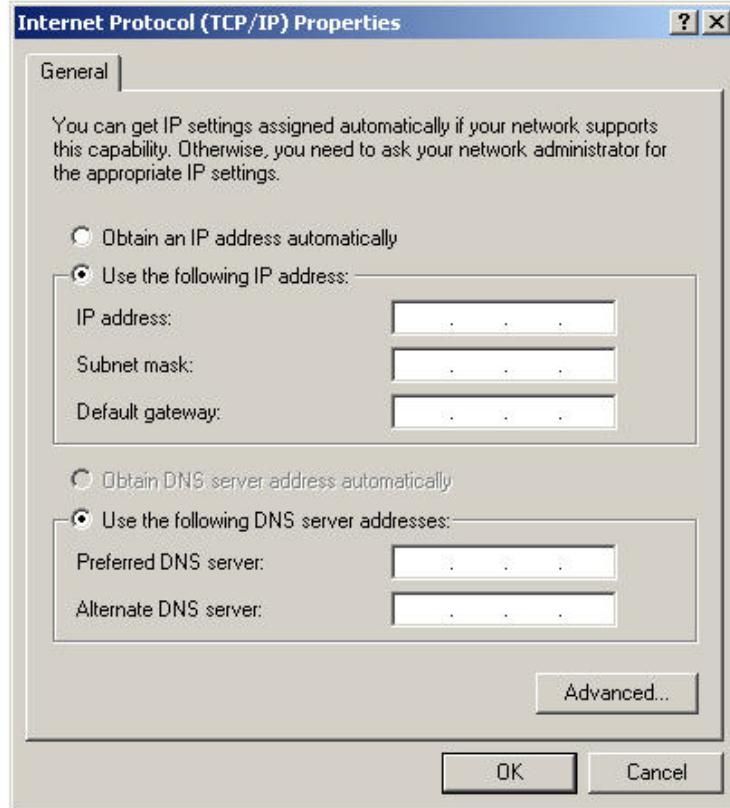

- Click on **Start > Settings > Control Panel** and then click the **Network Connection** icon.
- Select the **Local Area Network Connection** and click on **Change settings of this connection**.
- Select the **TCP/IP protocol** icon that is associated with the NIC in this PC.
- Click on **Properties** and click on **Use the following IP address**.
- Set the IP address information for each PC according to the information in the table.
- Note that the default gateway IP address is not required, since these computers are directly connected. The default gateway is only required on local area networks that are connected to a router.

PC	IP	Sub net mask	Gateway
Pc01	192.168.1.1	255.255.255.0	Not required
Pc02	192.168.1.2	255.255.255.0	Not required
Pc03	192.168.1.3	255.255.255.0	Not required

Step 5 Access the Command or MS-DOS prompt

Windows XP users should do the following:

Start > Programs > Accessories > Command Prompt

Step 4, Verify PC logical connection

a. Test connectivity from one PC to the other by pinging the IP address of the opposite computer.

Use the following command at the command prompt.

C:>ping 192.168.1.1 (or 192.168.1.2) (or 192.168.1.3)

b. Look for results similar to those shown below. If not, check the PC connections and TCP/IP

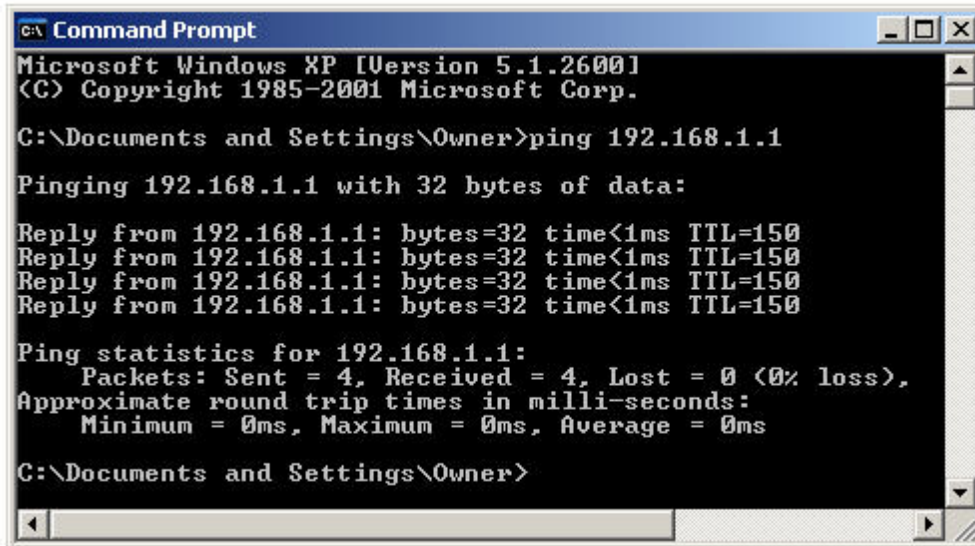

```
CA Command Prompt
Microsoft Windows XP [Version 5.1.2600]
(C) Copyright 1985-2001 Microsoft Corp.

C:\Documents and Settings\Owner>ping 192.168.1.1

Pinging 192.168.1.1 with 32 bytes of data:

Reply from 192.168.1.1: bytes=32 time<1ms TTL=150
Reply from 192.168.1.1: bytes=32 time<1ms TTL=150
Reply from 192.168.1.1: bytes=32 time<1ms TTL=150
Reply from 192.168.1.1: bytes=32 time<1ms TTL=150

Ping statistics for 192.168.1.1:
    Packets: Sent = 4, Received = 4, Lost = 0 (0% loss),
    Approximate round trip times in milli-seconds:
        Minimum = 0ms, Maximum = 0ms, Average = 0ms

C:\Documents and Settings\Owner>
```

c. test the logical path between PCs using tracert command as follows

c:\tracert 192.168.1.2

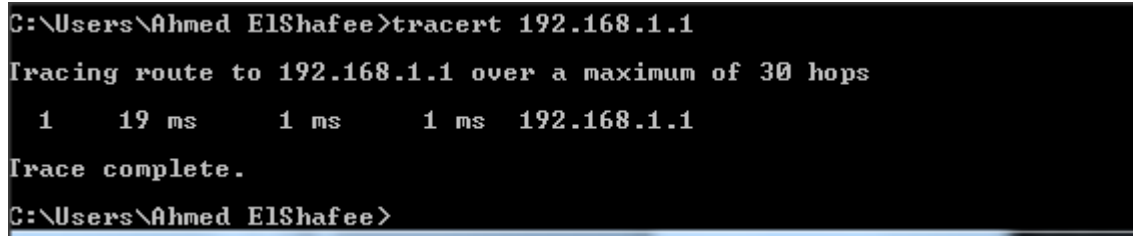

```
C:\Users\Ahmed ElShafee>tracert 192.168.1.1

Tracing route to 192.168.1.1 over a maximum of 30 hops
  0  19 ms  1 ms  1 ms  192.168.1.1
Trace complete.

C:\Users\Ahmed ElShafee>
```

* Round Trip Times (RTTs) in milliseconds, shows the time it took a packet to get from your machine to the server and back again, called the latency between the two systems.

By default, three packets are sent to each system along the route, so it shows three RTTs

Step 5, Confirm the TCP/IP network settings

Windows NT / 2000 / XP users should do the following:

Type the **ipconfig** command from the Command Prompt.

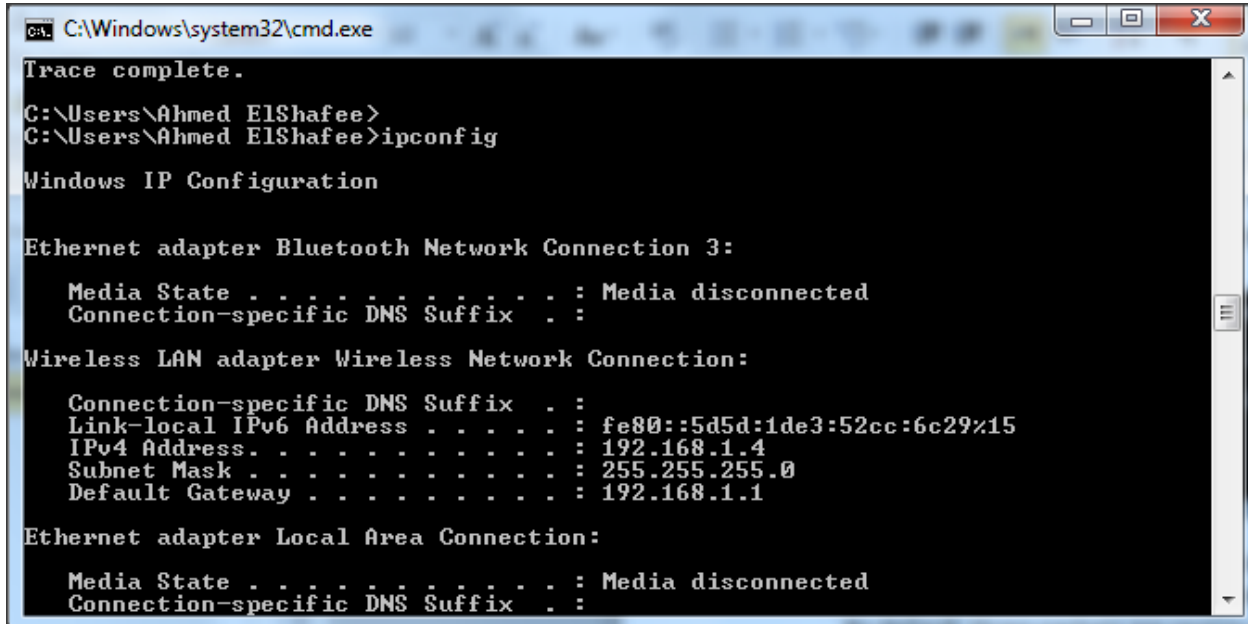

```
C:\Windows\system32\cmd.exe
Trace complete.
C:\Users\Ahmed ElShafee>
C:\Users\Ahmed ElShafee>ipconfig

Windows IP Configuration

Ethernet adapter Bluetooth Network Connection 3:

    Media State . . . . . : Media disconnected
    Connection-specific DNS Suffix  . :

Wireless LAN adapter Wireless Network Connection:

    Connection-specific DNS Suffix  . :
    Link-local IPv6 Address . . . . . : fe80::5d5d:1de3:52cc:6c29%15
    IPv4 Address. . . . . : 192.168.1.4
    Subnet Mask . . . . . : 255.255.255.0
    Default Gateway . . . . . : 192.168.1.1

Ethernet adapter Local Area Connection:

    Media State . . . . . : Media disconnected
    Connection-specific DNS Suffix  . :
```

Conclusions:

1. A hub based physical star topology is a logical bus topology network? Discuss?

.....

.....

.....

.....

.....

.....

.....

.....

.....

.....

.....

.....

.....

.....

.....

.....

.....

.....

.....

.....

.....

.....

2. A switch based physical star topology network is a logical star topology too. Discuss?

.....

.....

.....

.....

.....

.....

.....

.....

.....

.....

.....

.....

.....

.....

.....

.....

.....

.....

.....

.....

.....

.....

.....