

Electronic Circuits I – Laboratory 04

Special purpose diodes

#	Student ID	Student Name	Grade (10)	Instructor signature
1				
2				
3				
4				
5				

Delivery Date	
---------------	--

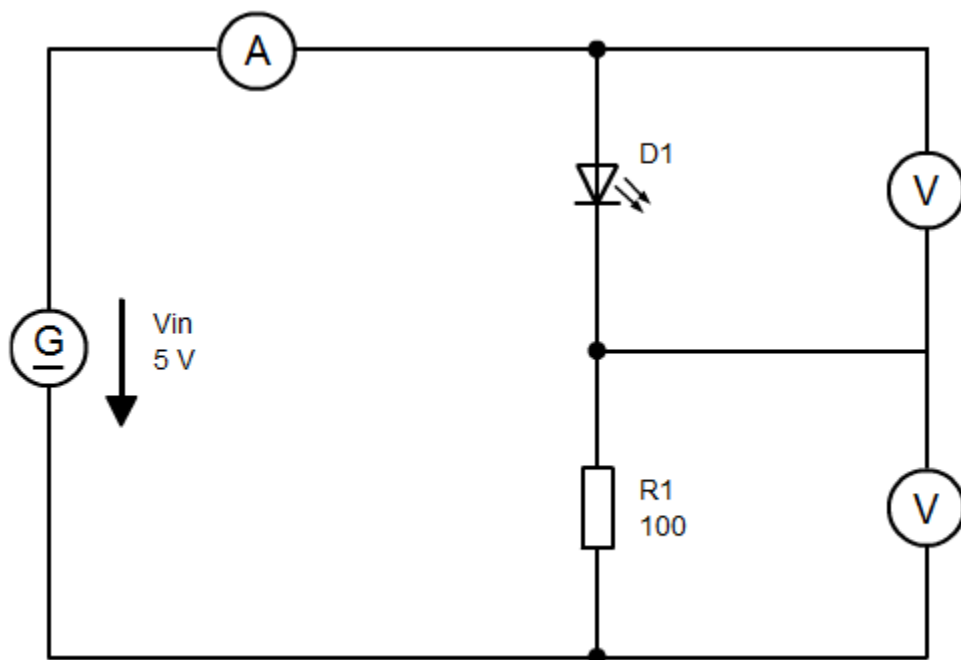

Part 1, Light emitting diode





Equipment

The following equipment is needed for this experiment and should be configured as shown:

Equipment	Settings	
	Black lead	Ground
	Red lead	400 mA input
	Selector knob	mA =
		Plug the red and black leads into the sockets indicated
	Positive input	A+
	Negative input	A-
	Selector knob	RMS



Experiment set-up

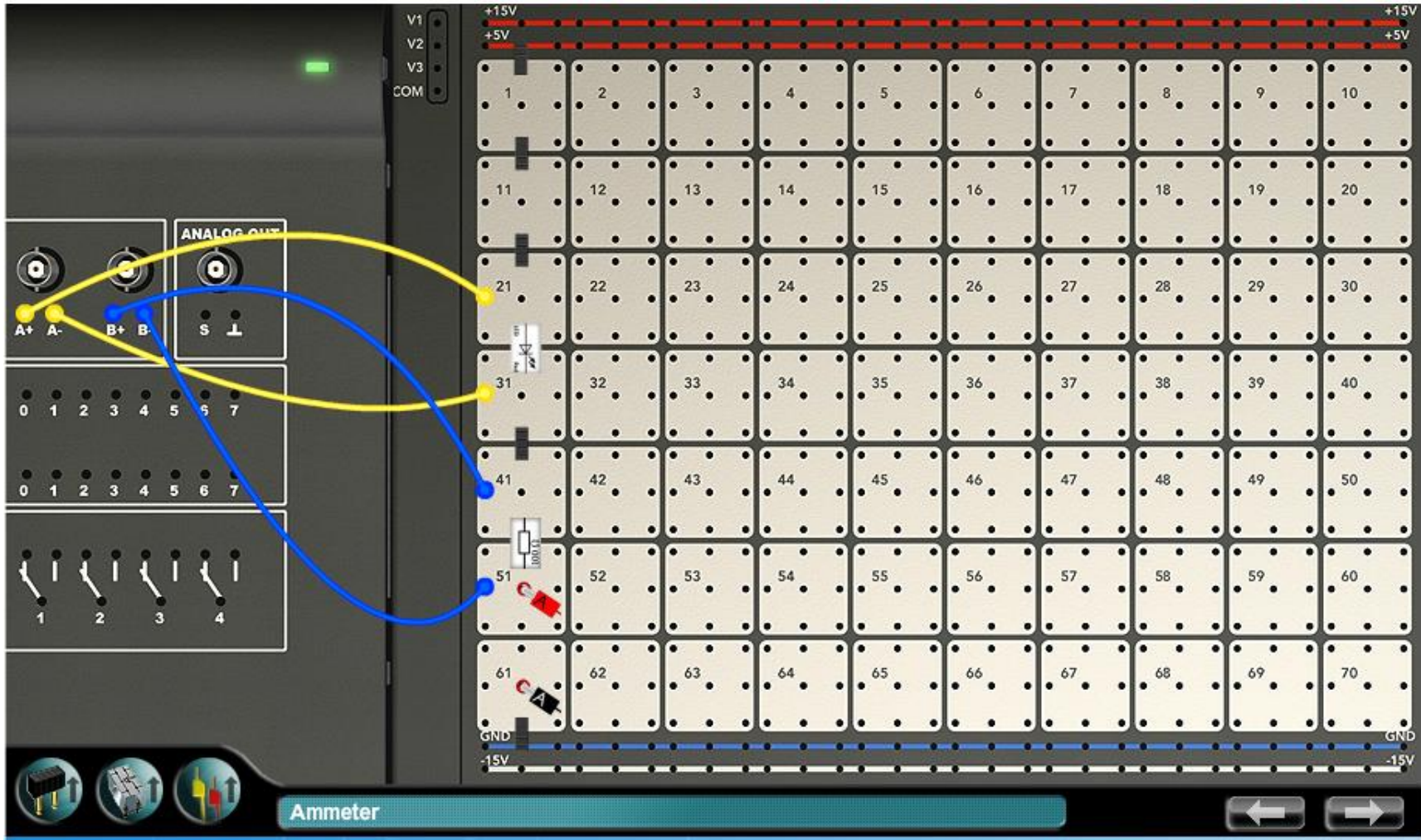

Experiment procedure and exercises

- Calculate the current from the voltage drop across the resistor using Ohm's law. Place the following components on the Experimenter one after the other: first the LEDs (red and green), then the germanium diode (Ge AA118), then the silicon diode (1N4007) and lastly the zener diode (ZPD 4.7). In each case, measure the threshold voltage for the various types of LEDs or diodes. To do this, place the diode in position and enter the voltage drop across the diode as well as the current.

Start by measuring voltage and current for the red LED.

V_T (V)	
I_T (mA)	

Now insert the green diode in the diode position. Measure the voltage and current and enter these values below.

V_T (V)	
I_T (mA)	

Now put the germanium diode in position. Measure the voltage and current and enter these values below.

V_T (V)	
I_T (mA)	

Now put the silicon diode in position. Measure the voltage and current and enter these values below.

V_T (V)	
I_T (mA)	

Now put the zener diode in position. Measure the voltage and current and enter these values below.

V_T (V)	
I_T (mA)	

Part 2; Zener diode

Circuit diagram

This experiment is based on the following circuit:

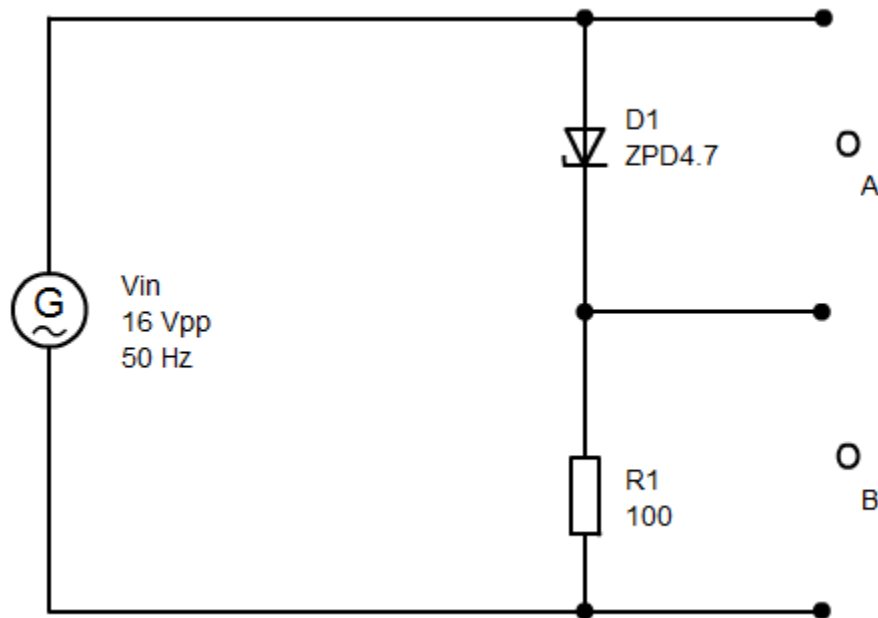

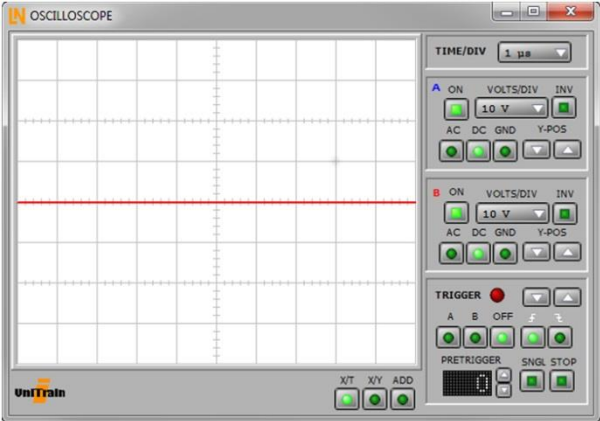
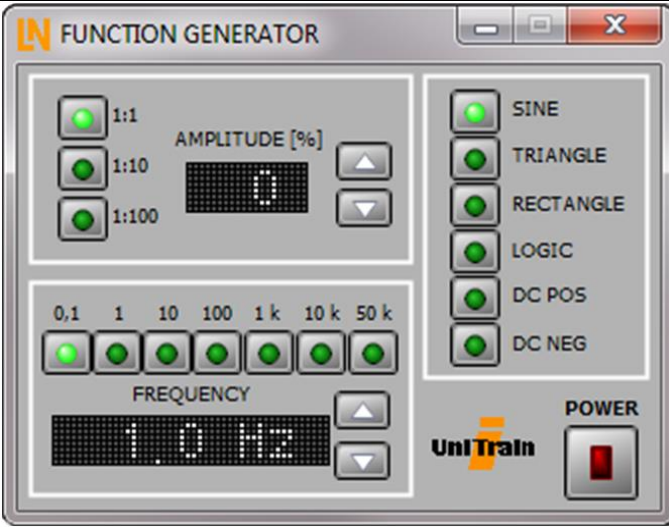

Equipment

Equipment	Settings		
		Channel A	Channel B
		Channel A	Channel B
Sensitivity		2 V/div	2 V/div
Coupling		DC	DC
Polarity		Normal	Normal
Time base		2 ms	
Mode		X/T	
Trigger channel		-	
Trigger edge		-	
	Waveform	Sine	
Amplitude		16 Vpp (80%, 1:1)	
Frequency factor		10	
Frequency		50 Hz	

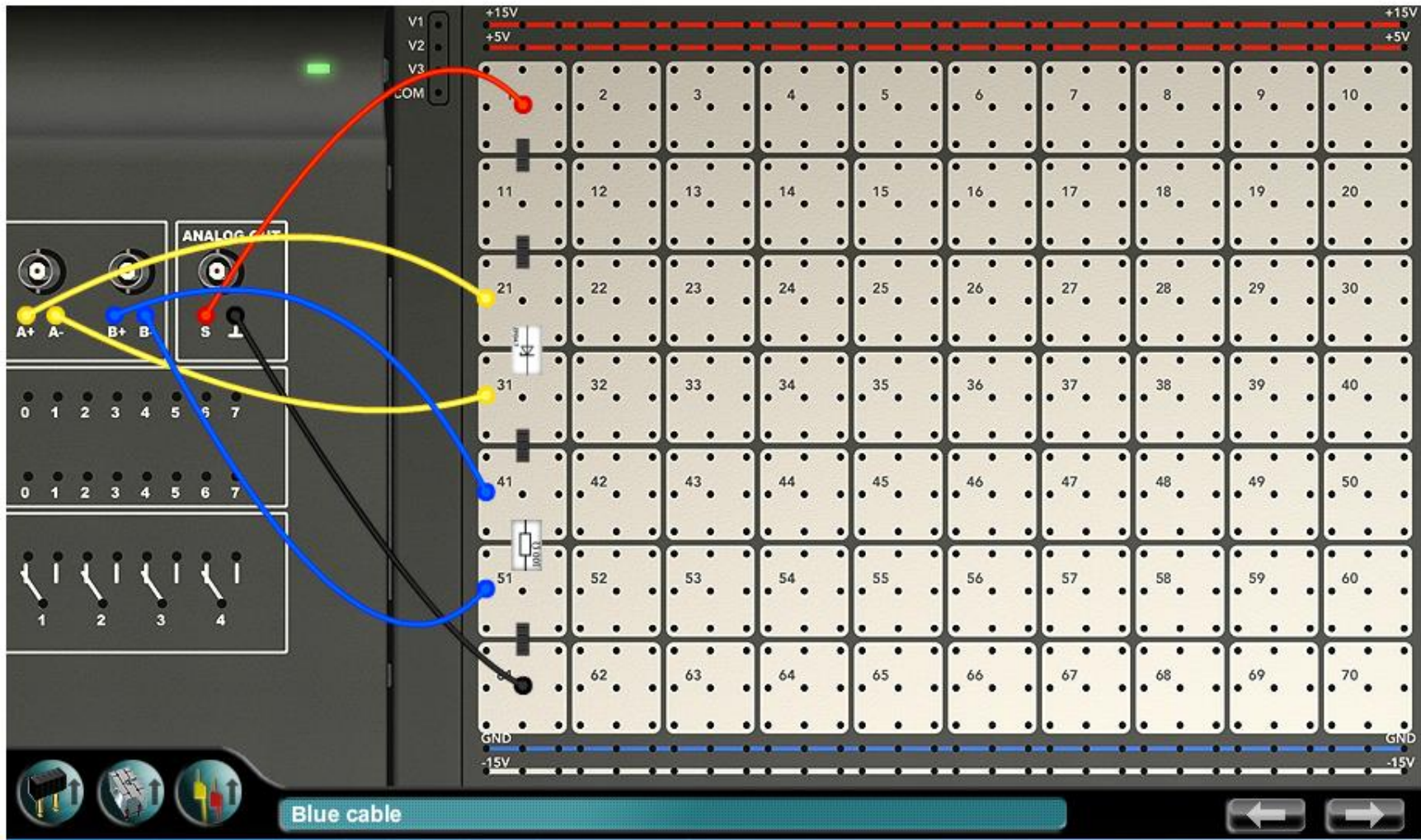

Experiment procedure and exercises

Configure the oscilloscope and function generator with the values given above and copy the current-voltage characteristic for a zener diode into the diagram. Make sure that you can easily read off the threshold voltage.

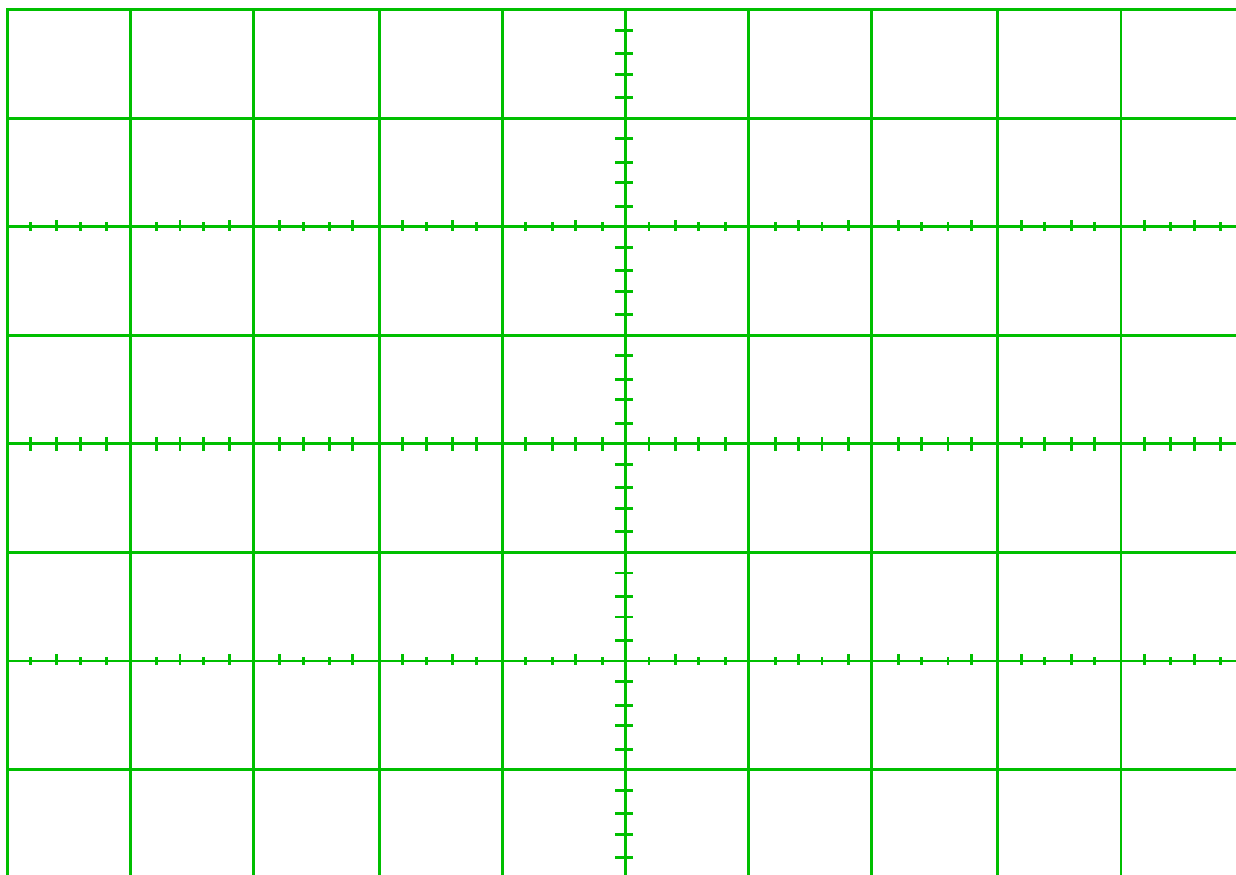

As of a certain voltage, its threshold voltage, the zener diode starts to conduct and the current rises almost instantaneously. In the forward-bias direction, the voltage curve corresponds to that of an ordinary diode. What is this low-voltage threshold?

V_{th} (Volts)	
------------------	--

What is the higher threshold exhibited when the diode is the opposite way round?

V_{th} (Volts)	
------------------	--