



Lecture (04) Network Access layer fundamentals I

By:

Dr. Ahmed ElShafee

Dr. Ahmed ElShafee, ACU : Fall 2014, Computer Networks II

-
- Typical LAN Features for Physical layer
 - Typical LAN Features for Data link layer
 - Standards Overview
 - 10BASE2 and 10BASE5
 - 10BASE-T

Dr. Ahmed ElShafee, ACU : Fall 2014, Computer Networks II

Foundation Topics

Ethernet is the undisputed king of LAN standards today.

Twenty five years ago, people wondered whether Ethernet or Token Ring would become win the battle of the LANs.

Eighteen years ago, it looked like Ethernet would win that battle, but it might lose to an upstart called Asynchronous Transfer Mode (ATM) in the LAN.

Today when you think of LANs, no one even questions what type—it's Ethernet.

Foundation Topics (2)

From the original commercial specifications that transferred data

- 10 megabits per second (Mbps),
- 100 megabits per second (Mbps),
- 1 gigabits per second (Gbps),
- 10 gigabits per second (Gbps).

Ethernet defines both Layer 1 and Layer 2 functions of OSI model.

2. data link layer
1. physical layer

Typical LAN Features for Physical layer

Definition

- The OSI physical layer defines the standards used to send and receive bits across a physical network.
- The OSI physical layer and its equivalent protocols in TCP/IP define all the details that allow the transmission of the bits from one device to the next.

Dr. Ahmed ElShafee, ACU Fall2014, Computer Networks II

Typical LAN Features for Physical layer

Consider the example of the web browser requesting a web page from the web server.

Following figure reminds you of the point at which Bob has built the HTTP, TCP, IP, and Ethernet headers, and is ready to send the data to R2.

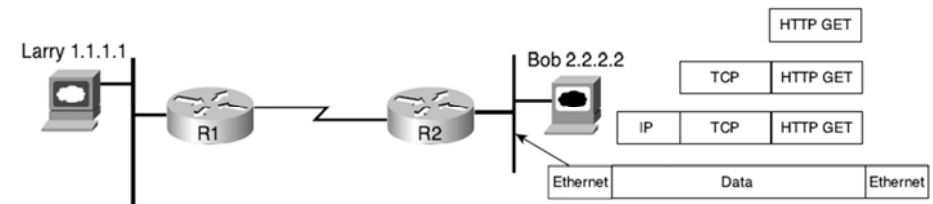

physical layer defines the details of cabling—

- the maximum length allowed for each type of cable (CAT5, 6,...),
- the number of wires inside the cable,
- The shape of the connector (RJ-45 connector) on the end of the cable,
- the purpose of each pin, or wire of cable.

For instance, on a standard Category 5 (CAT5) unshielded twisted-pair (UTP) Ethernet cable, pins 1 and 2 are used for transmitting and pins 3 and 6 are used for receiving data.

Dr. Ahmed ElShafee, ACU Fall2014, Computer Networks II

A straight-through cable

- connects pin 1 on one end of the cable with pin 1 on the other end, pin 2 on one end to pin 2 on the other, and so on.
- If you hold the cable so that you compare both connectors side by side, with the same orientation for each connector, you should see the same color wires for each pin with a straight-through cable.

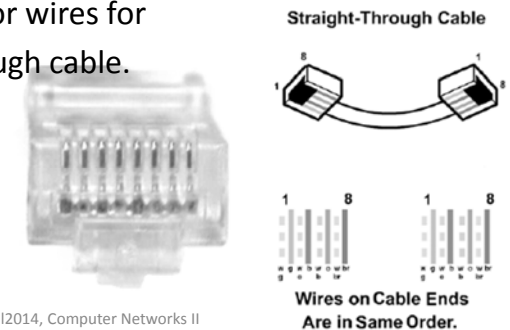

Dr. Ahmed ElShafee, ACU Fall2014, Computer Networks II

twisted pair cable

By twisting the wires, the electromagnetic interference caused by the electrical current is greatly reduced.

So, most LAN cabling uses two twisted pairs—one pair for transmitting and one for receiving.

Physical layer specs

Function	Description
Cabling	Defines the number of wires and the type of shielding used (or not used).
Connectors	Defines the shape of the connectors and the number of pins.
Pins	Defines the purpose of the pins. For instance, one pin might be used to signal to the other device whether it is allowed to send.
Voltage and current	Defines the electrical characteristics of the endpoint devices that use a cable.
Encoding	Defines how a device signals a binary 0 or 1 onto the transmit pin(s). For instance, +5V might mean 1, and -5V might mean 0. (Many encoding schemes

Typical LAN Features for data link layer

Definition

OSI Layer 2, the data link layer, defines the standards and protocols used to control the transmission of data across a physical network.

If you think of Layer 1 as “sending bits,”

you can think of Layer 2 as

- “1. knowing when to send the bits,
2. noticing when errors occurred when sending bits,
3. and identifying the computer that needs to get the bits.”

Functions

- **Arbitration**—Determines when it is appropriate to use the physical medium
- **Addressing**—Ensures that the correct recipient(s) receives and processes the data that is sent
- **Error detection**—Determines whether the data made the trip across the physical medium successfully
- **Identification of the encapsulated data**—Determines the type of header that follows the data link header

Data Link Function 1: Arbitration

Real life example

Imagine trying to get through an intersection in your car when all the traffic signals are out— you all want to use the intersection, but you had better use it one at a time.

You finally get through the intersection based on a lot of variables—

- how tentative you are,
- how big the other cars are,
- how new or old your car is, and
- how much you value your own life!



Regardless, you cannot allow cars from every direction to enter the intersection at the same time without having some potentially serious collisions.



What about the LAN?

- With some types of physical networks, data frames can collide if devices can send any time they want.
- Then the data in each frame is corrupted and the LAN is unusable.
- The specifications for these data-link protocols define how to arbitrate the use of the physical medium to avoid collisions, or at least to recover from the collisions when they occur.
- Ethernet uses the *carrier sense multiple access with collision detection (CSMA/CD) algorithm* for arbitration.

Data Link Function 2: Addressing

A real life example

- When I sit and have lunch with my friend "X", and just "X", he knows I am talking to him.
- I don't need to start every sentence by saying "Hey, "X"..."
- Now imagine that a few other people join us for lunch—I might need to say something like "Hey, "X"..." before saying something so that "X" knows I'm talking to him.

What about the LAN?

- Many physical networks allow more than two devices attached to the same physical network (shared medium).
- So, data-link protocols define addresses to make sure that the correct device listens and receives the data that is sent.
- By putting the correct address in the data-link header, the sender of the frame can be relatively sure that the correct receiver will get the data.
- It's just like sitting at the lunch table and having to say "Hey "X"..." before talking to "X" so that he knows you are talking to him and not someone else.

Addressing techniques

- Ethernet uses Media Access Control (MAC) addresses, which are 6 bytes long and are represented as a 12-digit hexadecimal number.
- Frame Relay typically uses a 10-bit-long address called a data-link connection identifier (DLCI)—notice that the name even includes the phrase *data link*.

Data Link Function 3: Error Detection

- *Error detection discovers whether bit errors occurred during the transmission of the frame.*
- To do this, most data-link protocols include a *frame check sequence (FCS) or cyclical redundancy check (CRC) field in the data-link trailer.*
- *This field contains a value that is the result of a mathematical formula applied to the data in the frame.*

-
- Error detection does not imply recovery;
 - most data links, including
 - IEEE 802.5 Token Ring and
 - 802.3 Ethernet,
 - do not provide error recovery.
 - The FCS allows the receiving device to notice that errors occurred and then discard the data frame.
 - Error recovery, which includes the resending of the data, is the responsibility of another protocol.

Data Link Function 4: Identifying the Encapsulated Data

- Finally, the fourth part of a data link identifies the contents of the Data field in the frame.
- The following figure shows a PC that uses both TCP/IP to talk to a web server and Novell IPX to talk to a Novell NetWare server or apple talk server.

Multiplexing Using Data-Link Type and Protocol Fields

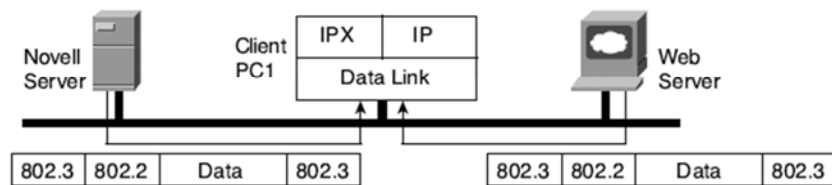

٢١

Dr. Ahmed ElShafee, ACU Fall2012, Network II

- When PC1 receives data, should it give the data to the TCP/IP software or the NetWare client software?
- Of course, that depends on what is inside the Data field. If the data came from the Novell server, PC1 hands off the data to the NetWare client code.
- If the data come from apple device, PC1 hands off the data to apple talk client code.
- If the data comes from the web server, PC1 hands it off to the TCP/IP code. But how does PC1 make this decision?

Multiplexing Using Data-Link Type and Protocol Fields

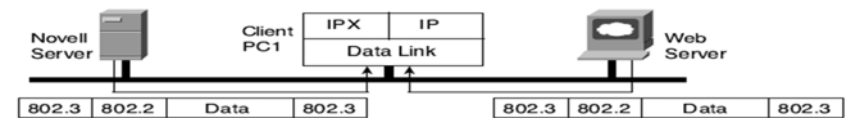

٢٢

- Well, IEEE Ethernet 802.2 Logical Link Control (LLC) uses a field in its header to identify the type of data in the Data field.
- PC1 examines that field in the received frame to decide whether the packet is an IP packet or an IPX packet, apple talk packet.

Multiplexing Using Data-Link Type and Protocol Fields

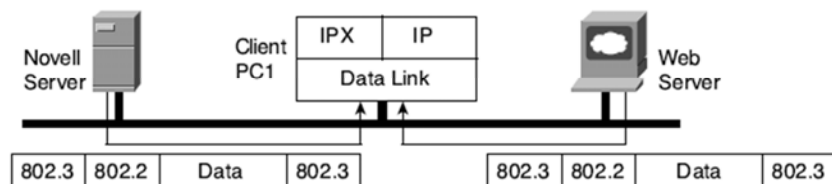

٢٣

Dr. Ahmed ElShafee, ACU Fall2012, Network II

- Each data-link header has a field, generically with a name that has the word *Type in it*, to identify the type of protocol that sits inside the frame's data field.
- In each case, the Type field has a code that means IP, IPX, apple talk or some other designation, defining the type of protocol header that follows.

Multiplexing Using Data-Link Type and Protocol Fields

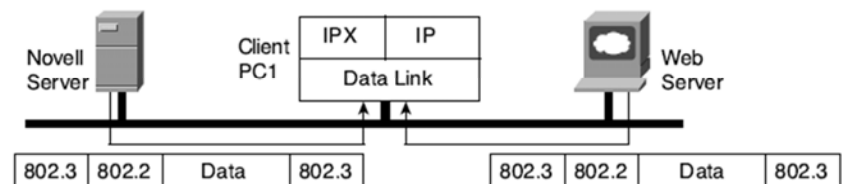

٢٤

Dr. Ahmed ElShafee, ACU Fall2012, Network II

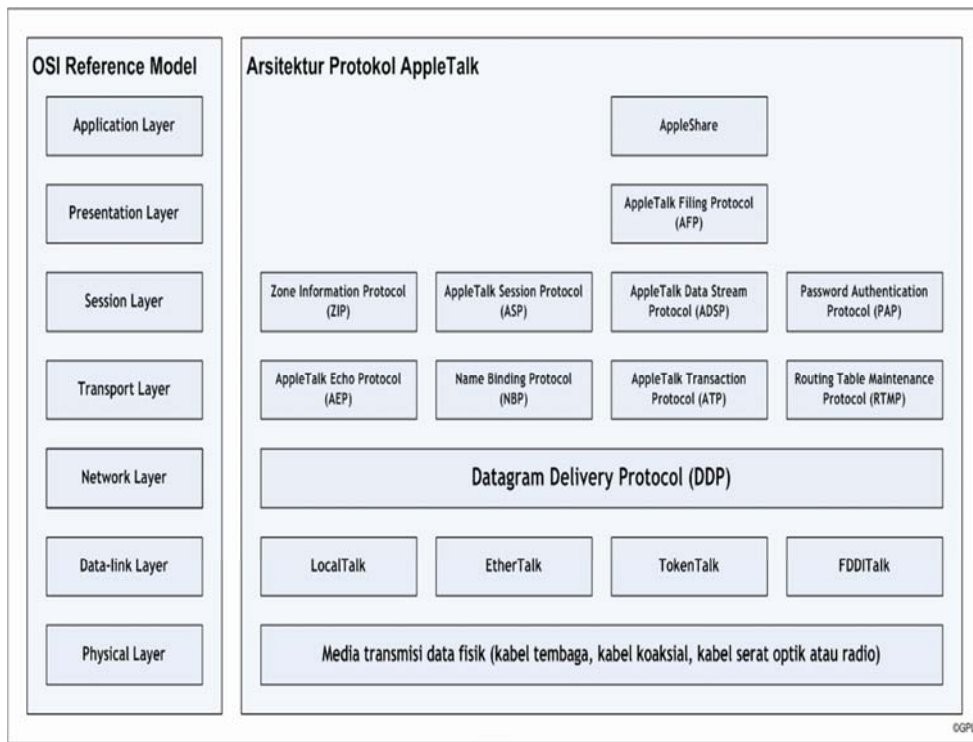

Standards Overview

- Like most protocols, Ethernet began life inside a corporation that was looking to solve a specific problem.
- Xerox needed an effective way to allow a new invention, called the personal Computc
- Eventually, Xerox teamed with Intel and Digital Equipment Corp. (DEC) to further develop Ethernet, so the original Ethernet became known as *DIX Ethernet*, meaning DEC, Intel, and Xerox.er, to be connected in its offices

IEEE role

- The IEEE began creating a standardized version of Ethernet in February 1980, building on the work performed by DEC, Intel, and Xerox.
- The IEEE Ethernet specifications that match OSI Layer 2 were divided into two parts:
 1. the *Media Access Control (MAC)* and
 2. *Logical Link Control (LLC)* sublayers.
- *The IEEE formed a committee to work on each part—the*
 1. 802.3 committee to work on the MAC sublayer, and
 2. 802.2 committee to work on the LLC sublayer.

MAC and LLC Standards for Three Types of LANs

Name	MAC Sublayer Spec	LLC Sublayer Spec
Ethernet Version 2 (DIX Ethernet)	Ethernet	—
IEEE Ethernet	IEEE 802.3	IEEE 802.2
IEEE Token Ring	IEEE 802.5	IEEE 802.2
ANSI FDDI	ANSI X3T9.5	IEEE 802.2

CSMA/CD

- early DIX Ethernet specifications called *10BASE5* and *10BASE2*, which differ in the cabling details
- Topology is a series of coaxial cables, connecting each device on the Ethernet network—there is no hub, switch, or wiring panel.
- The series of cables creates an electrical bus that is shared among all devices on the Ethernet.
- When a computer wants to send, all other computer receive it.

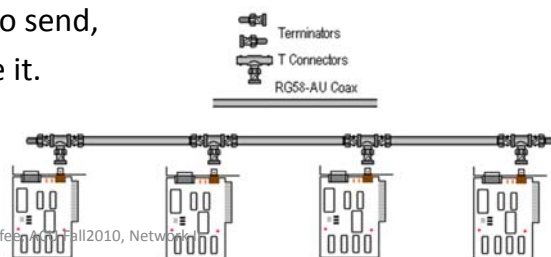

٣٩

Dr. Ahmed ElShafee, ACU Fall2010, Network II

- Because it is a single bus, if two or more signals were sent at the same time, the two would overlap and collide
- So Ethernet defined a specification to ensure that only one device sends traffic on the Ethernet at one time
- The algorithm, known as the *carrier sense multiple access with collision detection (CSMA/CD) algorithm*, defines how the bus is accessed.

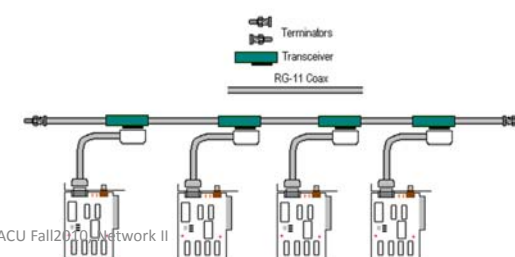

٣٠

Dr. Ahmed ElShafee, ACU Fall2010, Network II

CSMA real life example:

- In a meeting room with many attendees. Some people talk much of the time. Some do not talk, but they listen. Others talk occasionally.
- Being humans, it's hard to understand what two people are saying at the same time, so generally, one person is talking and the rest are listening



٣١

Dr. Ahmed ElShafee, ACU Fall2010, Network II

- Imagine that Bob and Larry both want to reply to the current speaker's comments.
- As soon as the speaker takes a breath, Bob and Larry might both try to speak.
 1. If Larry hears Bob's voice before Larry actually makes a noise, Larry might stop and let Bob speak.
 2. Or, maybe they both start at almost the same time, so they talk over each other and many others in the room can't hear what was said.
 3. Or, in some cases, another person jumps in and talks while Larry and Bob are both backing off.



٣٢

Dr. Ahmed ElShafee, ACU Fall2010, Network II

CSMA, the whole story:

- As shown in figure, Larry message propagates to Archie, and Bob.
- If two stations send messages at the same time, a collision occurs.
- The collision first occurs on the wire, and then some time elapses before the sending stations hear the collision (due to propagation delay)—so technically, the stations send a few more bits before they actually notice the collision.

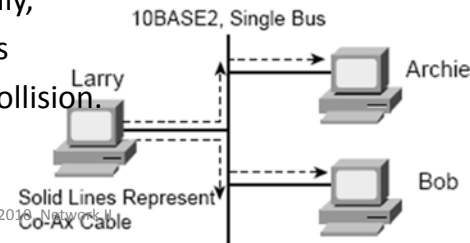

٣٣

Dr. Ahmed ElShafee, ACU Fall2010, Network II

CSMA/CD algorithm:

1. A device with a frame to send listens until the Ethernet is not busy.
2. When the Ethernet is not busy, the sender begins sending the frame.
3. The sender listens to make sure that no collision occurred.

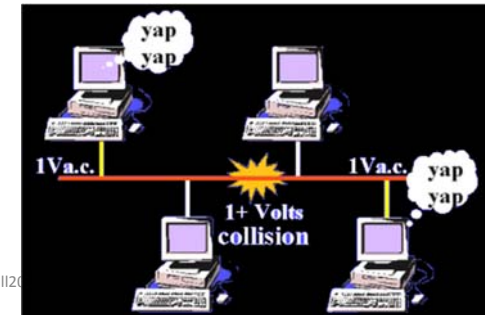

٣٤

Dr. Ahmed ElShafee, ACU Fall2010, Network II

4. Once the senders hear the collision, they each send a jamming signal, to ensure that all stations recognize the collision.
5. After the jamming is complete, each sender randomizes a timer and waits a while.
6. When each timer expires, the process starts over with Step 1.

So, all devices on the Ethernet need to use CSMA/CD to avoid collisions and to recover when inadvertent collisions occur.

٣٥

Dr. Ahmed ElShafee, ACU Fall2010, Network II

Ethernet standards

Repeaters

- 10BASE5 and 10BASE2 had limitations on the total length of a cable.
 1. 10BASE5, the limit was 500 m
 2. 10BASE2, it was 185 m.
- Interestingly, these two types of Ethernet get their name from the maximum segment lengths—
- if you think of 185 m as being close to 200 m, then the last digit of the names defines the multiple of 100 m that is the maximum length of a segment.
- That's really where the 5 and the 2 came from in the names.

٣٦

Dr. Ahmed ElShafee, ACU Fall2010, Network II

Why repeater?

- One of the problems with using longer segment lengths was that the signal sent by one device could attenuate too much if the cable was longer than 500 m or 185 m, respectively.
- *Attenuation means that when electrical signals pass over a wire, the strength of the signal gets smaller the farther along the cable it travels.*
- It's the same concept behind why you can hear someone talking right next to you, but if that person speaks at the same volume and you are across the room, you might not hear her because the sound waves have attenuated.



٣٧

Dr. Ahmed ElShafee, ACU Fall2010, Network II

Segmentation using repeaters;

- Repeaters allow multiple segments to be connected by taking an incoming signal, interpreting the bits as 1s and 0s, and generating a brand new, clean signal.
- A repeater does not simply amplify the signal because amplifying the signal might also amplify any noise picked up along the way.

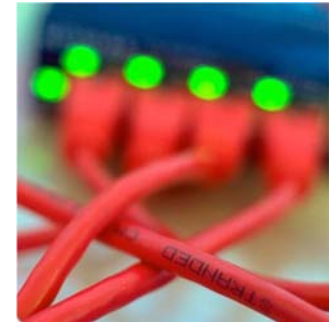

٣٨

Dr. Ahmed ElShafee, ACU Fall2010, Network II

- 10BASE-T allowed the use of telephone cabling that was already installed, or simply allowed the use of cheaper, easier-to-install cabling when new cabling was required.
- 10BASE-T networks make use of devices called
 1. *Network card*
 2. *hub*

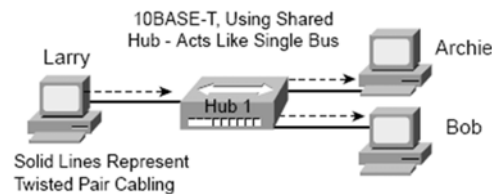

٣٩

Dr. Ahmed ElShafee, ACU Fall2010, Network II

Hubs:

- The hubs used to create a 10BASE-T Ethernet are essentially multiport repeaters.
- That means that the hub simply regenerates the electrical signal that comes in one port and sends the same signal out every other port.
- By doing so, 10BASE-T creates an electrical bus, just like 10BASE2 and 10BASE5.
- Therefore, collisions can still occur, so CSMA/CD access rules continue to be used.

٤٠

Dr. Ahmed ElShafee, ACU Fall2010, Network II

10Base-T is more reliable than 10Base2/5

- The use of 10BASE-T hubs gives Ethernet much higher availability compared with 10BASE2 and 10BASE5
- because a single cable problem could, and probably did, take down those types of LANs.
- With 10BASE-T, a cable is run from each device to a hub, so a single cable problem affects only one device.

٤١

Dr. Ahmed ElShafee, ACU Fall2010, Network II

Topology:

- Physically hub creates star network (hub is the core of network), but logically it's still a bus network.
- we call this *shared Ethernet: All devices are sharing a single 10-Mbps bus.*

٤٢

Dr. Ahmed ElShafee, ACU Fall2010, Network II

Ethernet 10BASE-T Cabling

Category 5 UTP cables with RJ-45 connectors

- the pair of wires on pins 1 and 2 is used to transmit data, and pins 3 and 6 are used for receiving data (network card /hub).
- The cable used to connect the PCs to the hub is called a *straight-through cable*,

Straight-Through Ethernet Cable with Exaggerated RJ-45 Connectors

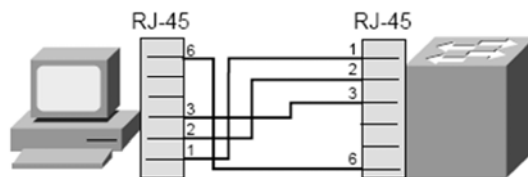

٤٣

Dr. Ahmed ElShafee, ACU Fall2010, Network II

- you might want to create a small Ethernet between two PCs simply by cabling the two PCs together
- Use a special cable called a *crossover cable*.
- pin 1 on one end of the cable becomes pin 3 on the other end. Similarly, pin 2 is connected to pin 6 at the other end, pin 3 is connected to pin 1, and pin 6 is connected to pin 2.

Crossover Ethernet Cable

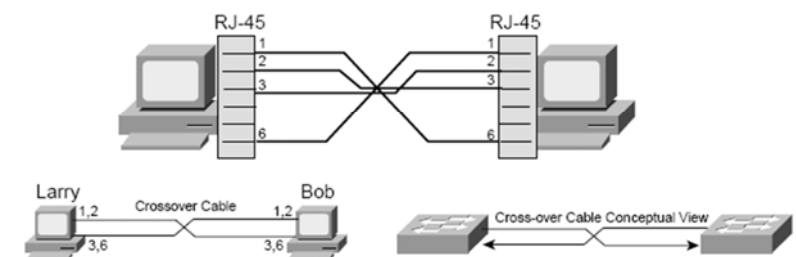

٤٤

Expanding network:

- Most of the time, you will not actually connect two computers directly with an Ethernet cable.
- However, you typically will use crossover cables for connections between switches and hubs.
- An Ethernet cable between two hubs or switches often is called a *trunk*.

Typical Uses for Straight-Through and Crossover Ethernet Cables

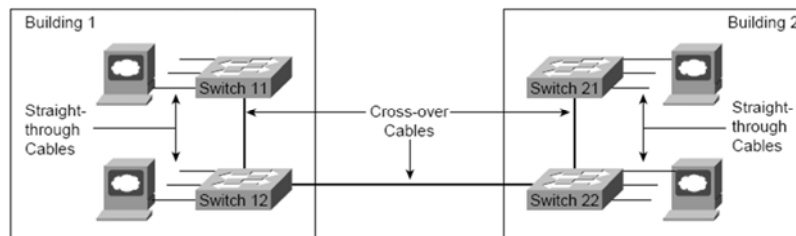

10Base-T & CSMA/CD

- 10BASE-T still created a single electrical bus shared among all devices on the LAN.
- Ethernets that share a bus cannot reach 100 percent utilization because of collisions and the CSMA/CD arbitration algorithm.

Hub layout

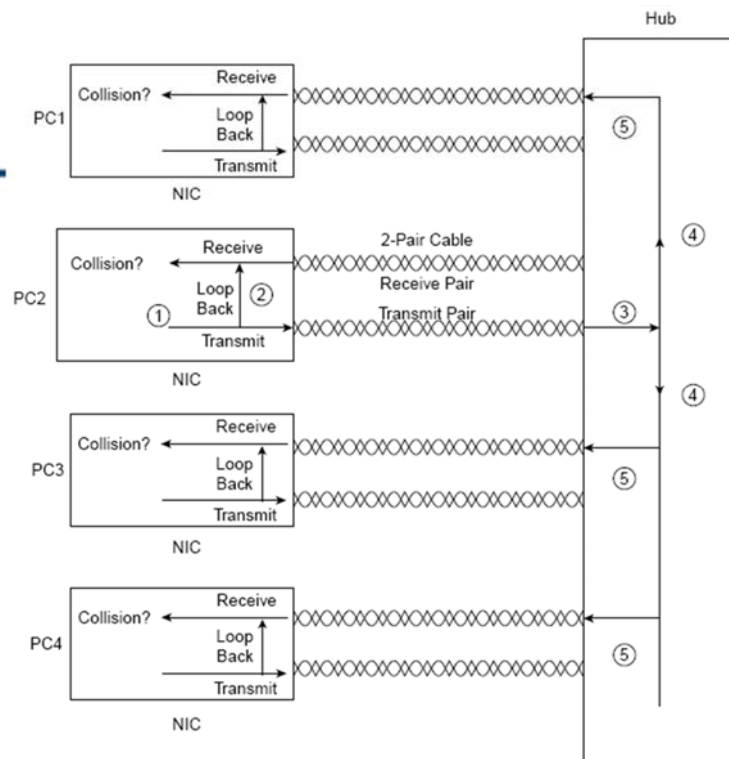

Hub operation:

1. The network interface card (NIC) sends a frame.
2. The NIC loops the sent frame onto its receive pair internally on the card.
3. The hub receives the frame.
4. The hub's internal wiring propagates the signal to all other ports, but not back to the port that the signal was received upon.
5. The hub repeats the signal to each receive pair to all other devices.

Is there a need for CSMA/CD?

- If PC1 and PC2 sent a frame at the same time, a collision would occur.
- At Steps 4 and 5, the hub would forward both electrical signals, which would cause the overlapping signals to be sent to all the NICs.
- So, because collisions can occur, CSMA/CD logic still is needed to have PC1 and PC2 wait and try again.

Notes:

- NOTE PC2 would sense a collision because of its loopback circuitry on the NIC.
- The hub does not forward the signal that PC2 sent to the hub back to PC2.
- Instead, each NIC loops the frame that it sends back to its own receive pair on the NIC, as shown in Step 2 of the figure.
- Then, if PC2 is sending a frame and PC1 also sends a frame at the same time, the signal sent by PC1 is forwarded by the hub to PC2 on PC2's receive pair.
- The incoming signal from the hub, plus the looped signal on PC2's NIC, lets PC2 notice that there is a collision.

Performance Issues: Collisions and Duplex Settings

- 10BASE2, 10BASE5, and 10BASE-T Ethernet would not work without CSMA/CD.
- However, because of the CSMA/CD algorithm, Ethernet becomes more inefficient under higher loads.
- In fact, during the years before LAN switches made these types of phenomena go away, the rule of thumb was that an Ethernet began to degrade when the load began to exceed 30 percent (**30%**) utilization.

Reducing Collisions Through LAN Switching

- LAN switches overcome the problems created by collisions and the CSMA/CD algorithm by removing the possibility of a collision.
- switches do not create a single shared bus, like a hub; they treat each individual physical port as a separate bus.
- Switches use memory buffers to hold incoming frames as well, so when two attached devices send a frame at the same time, the switch can forward one frame while holding the other frame in a memory buffer, waiting to forward one frame until after the first one has been forwarded.

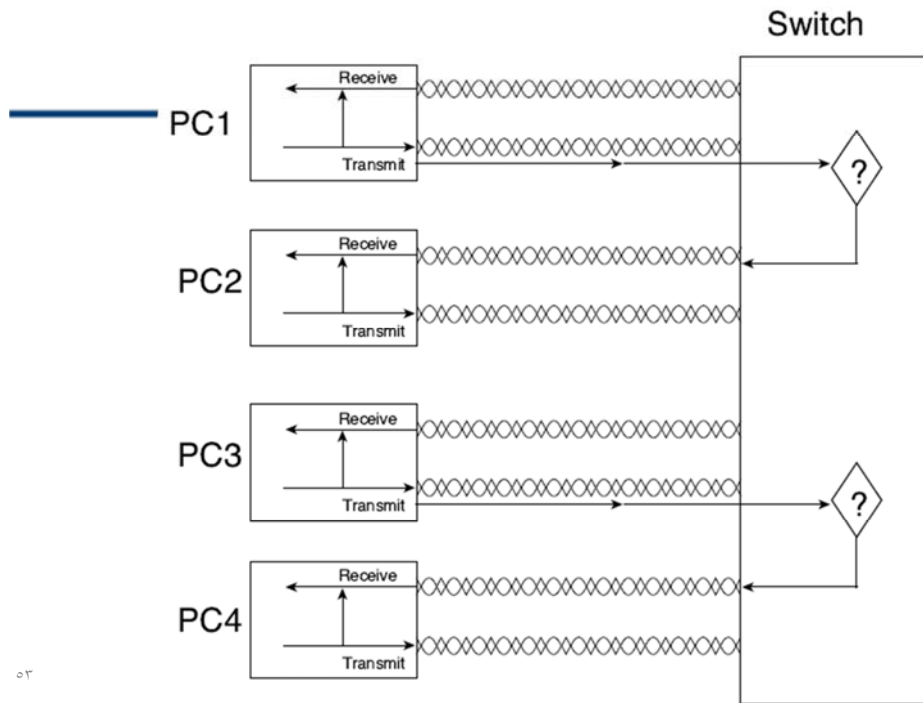

- both PC1 and PC3 are sending at the same time.
- The switch looks at the destination Ethernet address and sends the frame sent from PC1 to PC2 at the same instant as the frame is sent by PC3 to PC4.
- The big difference between the hub and the switch is that the switch interpreted the electrical signal as an Ethernet frame and processed the frame to make a decision.

٥٣

٥٤

Dr. Ahmed ElShafee, ACU Fall2010, Network II

Switching layer and Hub layer:

- A hub simply repeats the electrical signal and makes no attempt to interpret the electrical signal (Layer 1) as a LAN frame (Layer 2).
- So, a hub actually performs OSI Layer 1 functions, repeating an electrical signal, whereas a switch performs OSI Layer 2 functions, actually interpreting Ethernet header information, particularly addresses, to make forwarding decisions.

What if two PCs decide to send frames to same PC?

- Buffering also helps prevent collisions.
- Imagine that PC1 and PC3 both sent a frame to PC4 at the same time.
- The switch, knowing that forwarding both frames to PC4 would cause a collision, would buffer one frame until the first one has been completely sent to PC4.

٥٥

Dr. Ahmed ElShafee, ACU Fall2010, Network II

٥٦

Dr. Ahmed ElShafee, ACU Fall2010, Network II

Summary of switch advantages:

- If only one device is cabled to each port of a switch, no collisions occur.
- If no collisions can occur, CSMA/CD can be disabled, solving the Ethernet performance problem.
- Each switch port does not share the bandwidth, but it has its own separate bandwidth, meaning that a switch with a 10-Mbps ports has 10 Mbps of bandwidth *per port*.

Half duplex Ethernet

- The original Ethernet specifications used a shared bus, over which only one frame could be sent at any point in time.
- So, a single device could not be sending a frame and receiving a frame at the same time because it would mean that a collision was occurring.
- So, devices simply chose not to send a frame while receiving a frame.
- that logic is called *half-duplex* logic.

Full duplex Ethernet

- Ethernet switches allow multiple frames to be sent over different ports at the same time.
- Additionally, if only one device is connected to a switch port, there is never a possibility that a collision could occur.
- So, LAN switches with only one device cabled to each port of the switch allow the use of *full-duplex operation*.
- *Full duplex means that an Ethernet card can send and receive concurrently.*

10BASE-T Full-Duplex Operation Using a Switch

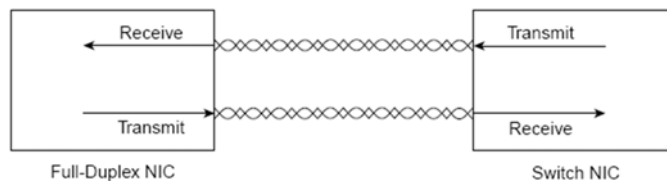

- For this to work, the NIC must disable its loopback circuitry

Summary of Some Basic Ethernet Features

Ethernet Environment	Description
10BASE2, 10BASE5	Single bus cabled serially between devices using coaxial cable. Neither is used much today.
10BASE-T with a Hub	One electrical bus shared among all devices creating a single collision domain, cabled in a star topology using twisted-pair cabling.
10BASE-T with a Switch	One electrical bus per switch port creating multiple collision domains, cabled in a star physical topology but a logical bus topology using twisted-pair cabling.
Half Duplex	Logic that requires a card to only send or receive at a single point in time. Used to avoid collisions.
Full Duplex	Logic that enables concurrent sending and receiving, allowed when one device is attached to a switch port, ensuring that no collisions can occur.



**Thanks,..
See you next week (ISA),...**