

Lecture (02)

The TCP/IP Networking Model

Dr. Ahmed M. ElShafee

Dr. Ahmed ElShafee, ACU Fall2012, Network II

Agenda

- Introduction to *networking architecture*
- Historical background
- The TCP/IP Protocol Architecture
 - The TCP/IP Application Layer
 - The TCP/IP Transport Layer
 - The TCP/IP Internetwork Layer
 - The TCP/IP Network Interface Layer
 - Network access layer
 - Physical layer
- Data Encapsulation

Dr. Ahmed ElShafee, ACU Fall2012, Network II

Introduction to *networking architecture*

- The term *networking model*, or *networking architecture*, refers to an organized description of all the functions needed for useful communications to occur.
- Networking model like you think of a set of architectural plans for building a house.



Dr. Ahmed ElShafee, ACU Fall2012, Network II

Introduction to *networking architecture* (2)

- Sure, you can build a house without the architectural plans, but it will work better if you follow the plans.
- And because you probably have a lot of different people working on building your house, such as framers, electricians, bricklayers, painters, and so on, it helps if they can all reference the same plan.



Dr. Ahmed ElShafee, ACU Fall2012, Net

Introduction to *networking architecture* (3)

- Similarly, you could build your own network, write your own software, build your own networking cards, and create a network without using any existing networking model.
- However, it is much easier to simply buy and use products that already conform to some well-known networking model.



Historical background

- Every Microsoft, Linux, and UNIX operating system includes support for TCP/IP.
- Hand-held digital assistants and cell phones support TCP/IP.
- Even IBM Mainframe operating systems support TCP/IP.
- Once upon a time, there were no networking protocols, including TCP/IP.
- Vendors created the first networking protocols; these protocols supported only that vendor's computers, and the details were not even published to the public.
- As time went on, vendors formalized and published their networking protocols, enabling other vendors to create products that could communicate with their computers

7

Dr. Ahmed ElShafee, ACU Fall2012, Network II

Historical background (2)

- However, to talk to a computer using the hardware or software from vendor X, you needed to use the networking protocols created by vendor X.
- Imagine sitting at your desk in the late 1980s and needing to work with an IBM mainframe using SNA (Systems Network Architecture), a DEC minicomputer using DECnet, and a Novell server using NetWare, and having to transfer files with an Apple computer using AppleTalk.
- Believe it or not, it actually worked, and networks using all these different protocols were not at all uncommon.

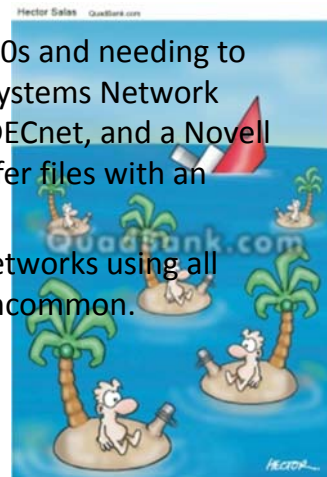

Historical background (3)

The International Organization for Standardization (ISO) took on this task starting as early as the late 1970s, beginning work on what would become known as the **Open Systems Interconnection (OSI)** networking model.

The ISO had a noble goal for the OSI: to standardize data networking protocols to allow communication between all computers across the entire planet.



8

Dr. Ahmed ElShafee, ACU Fall2012, Network II

9

Dr. Ahmed ElShafee, ACU Fall2012, Network II

Historical background (4)

- U.S. Defense Department did a less formal effort to create a standardized, public networking model sprouted forth from a contract.
- Researchers at various universities volunteered to help further develop the protocols surrounding the original department's work.
- These efforts resulting in a competing networking model called TCP/IP.



Historical background (5)

The world now had many competing vendor networking models and two competing standardized networking models. So what happened? TCP/IP won the war.

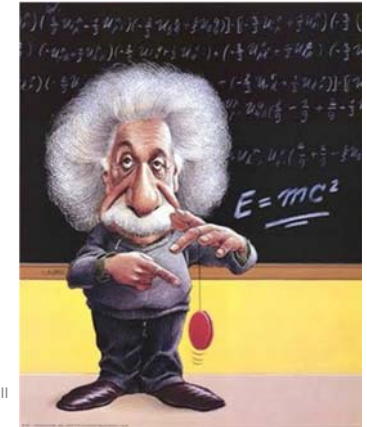

Historical background (6)

OSI Model Layers	TCP/IP Protocol Architecture Layers
Application Layer	Application Layer
Presentation Layer	
Session Layer	
Transport Layer	Host-to-Host Transport Layer
Network Layer	Internet Layer
Data-Link Layer	Network Interface Layer
Physical Layer	

Dr. Ahmed ElShafee, ACU Fall2010, Network II

The TCP/IP Protocol Architecture

Overview

TCP/IP defines a large collection of protocols that allow computers to communicate.

these protocols inside document called Requests For Comments (RFCs).

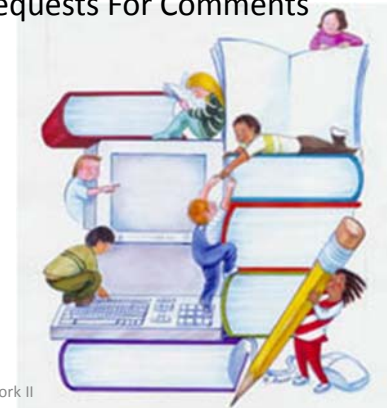

The TCP/IP Protocol Architecture (2)

An easy comparison can be made between telephones and computers that use TCP/IP.

you can buy a phone from one of a dozen different vendors.

When you get home, you plug the phone in to the wall socket, and it works.

The phone vendors know the standards for phones in their country and build their phones to match those standards.

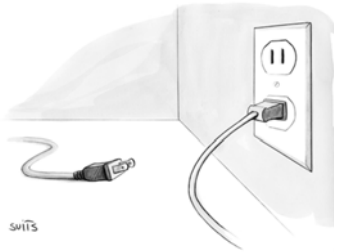

Dr. Ahmed ElShafee, ACU Fall2012, Network II



The TCP/IP Protocol Architecture (3)

Similarly, a computer that implements the standard networking protocols defined by TCP/IP can communicate with other computers that also use the TCP/IP standards.



14

Dr. Ahmed ElShafee, ACU Fall2012, Network II

The TCP/IP Protocol Architecture (4)

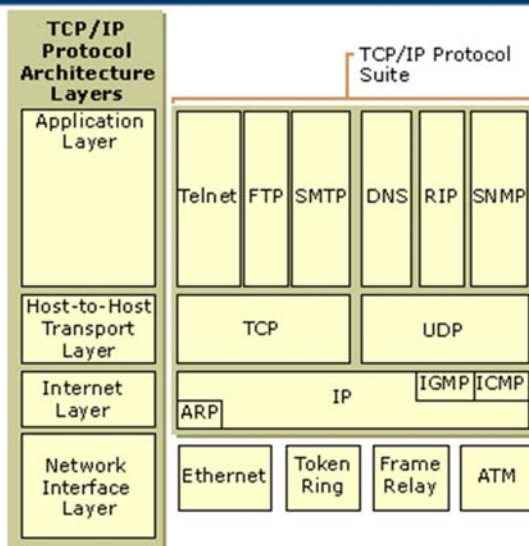

15

Dr. Ahmed ElShafee, ACU Fall2010, Network II

1. The TCP/IP Application Layer

- The most popular TCP/IP application today is the web browser.
- Many major software vendors either have already changed or are changing their software to support access from a web browser.
- Using a web browser is easy—you start a web browser on your computer and select a web site by typing in the name of the web site, and the web page appears.



16

Dr. Ahmed ElShafee, ACU Fall2012, Network II

1. The TCP/IP Application Layer (2)

- **What really happens** to allow that web page to appear on your web browser?
- Imagine Bob opened his web browser, and wrote in address bar Larry Web Server address.
- Bob's initial request actually asks Larry to send his home page back to Bob.

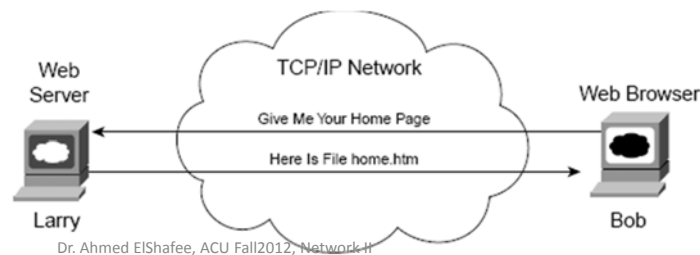

17

Dr. Ahmed ElShafee, ACU Fall2012, Network II

1. The TCP/IP Application Layer (3)

- Larry's web server software has been configured to know that Larry's default web page is contained in a file called Index.htm.
- File is transferred according to the Hypertext Transfer Protocol (HTTP). [not most urls starts with http://]
- Bob receives the file from Larry as HTML file.
- HTML defines how Bob's web browser should interpret the text inside the file he just received.
- For instance, the file might contain directions about making certain text be a certain size, color, and so on.

18

Dr. Ahmed ElShafee, ACU Fall2012, Network II

1. The TCP/IP Application Layer (4)

- In most cases, it also includes directions about other files that Bob's web browser should get— things such as graphics images and animation. HTTP would then be used to get those additional files from Larry, the web server.



19

Dr. Ahmed ElShafee, ACU Fall2012, Network II

1. The TCP/IP Application Layer (5)

HTTP in depth

- Bob sends something called an HTTP header to Larry.
- This header includes the command to “get” a file. The request typically contains the name of the file (home.htm in this case), or, if no filename is mentioned, the web server assumes that Bob wants the default web page.

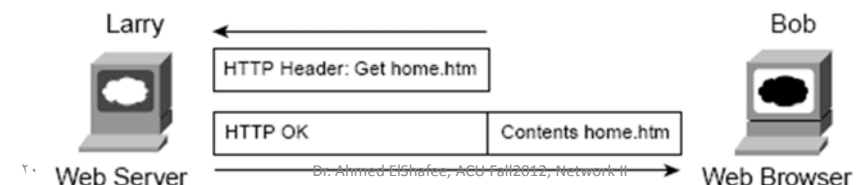

20

Dr. Ahmed ElShafee, ACU Fall2012, Network II

1. The TCP/IP Application Layer (6)

- The response from Larry includes an HTTP header as well, with something as simple as “OK” returned in the header.
- If web page that you looked for was not found, then you received an HTTP 404 “not found” error, When the requested file is found, the return code is 0.

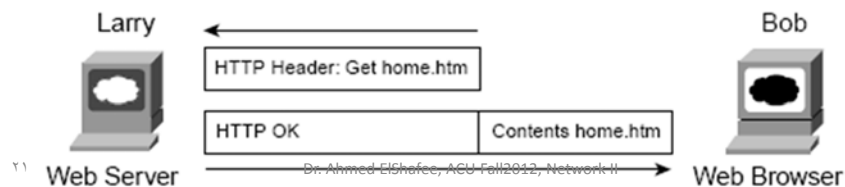

1. The TCP/IP Application Layer (7)

same-layer interaction concept;

- When a particular layer wants to communicate with the same layer on another computer, the two computers use headers to hold the information that they want to communicate.
- The headers are part of what is transmitted between the two computers. This process is called *same-layer interaction*.

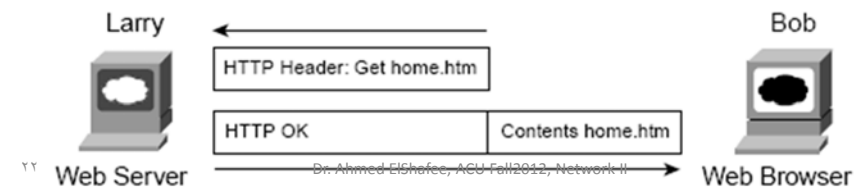

1. The TCP/IP Application Layer (8)

Summary

- TCP/IP application layer protocols provide services to the application software running on a computer.
- The application layer does not define the application itself, but rather it defines services that applications need—like the ability to transfer a file in the case of HTTP.
- In short, the application layer provides an interface between software running on a computer and the network itself.

2. The TCP/IP Transport Layer

Overview

- The TCP/IP transport layer consists of two main protocol options— the Transmission Control Protocol (TCP) and the User Datagram Protocol (UDP).
- To understand what the transport layer protocols do, you must think about the layer above the transport layer, the application layer.
- Why? because, each layer provides a service to the layer above it.

2. The TCP/IP Transport Layer (2)

- Transport layer is responsible of identify and distinguishing packets of each software program running inside the same host (PC)
- Each software defines its default destination port and random source port.
- both ports are included in TCP header.

20

Dr. Ahmed ElShafee, ACU Fall2010, Network II

2. The TCP/IP Transport Layer (3)

- Bob and Larry used HTTP to transfer the home page from Larry to Bob.
- But what would have happened if Bob's HTTP get request was lost in transit through the TCP/IP network? Or, what would have happened if Larry's response, which includes the contents of the home page, was lost?
- Well, the page would not show up in Bob's browser, as you might expect.

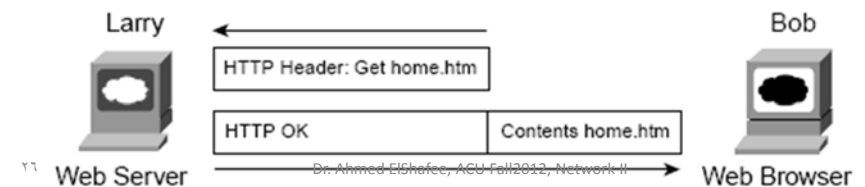

2. The TCP/IP Transport Layer (4)

- So, TCP/IP needs a mechanism to guarantee delivery of data across a network. TCP provides that feature by using acknowledgments.
- the HTTP software asks for TCP to reliably deliver the HTTP get request. TCP sends the HTTP data from Bob to Larry, and the data arrives successfully.

21

Dr. Ahmed ElShafee, ACU Fall2012, Network II

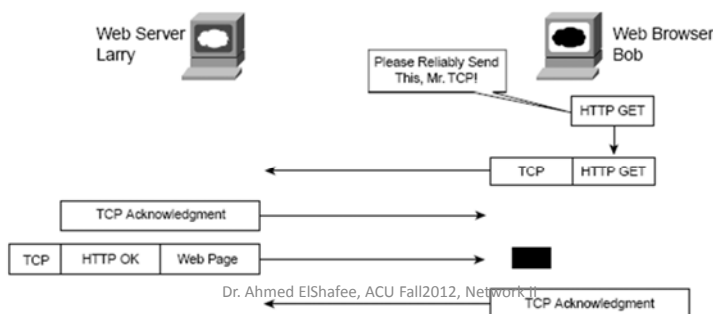

2. The TCP/IP Transport Layer (5)

- Larry's TCP software acknowledges receipt of the data and also gives the HTTP get request to the web server software. The reverse happens with Larry's response, which also arrives at Bob successfully

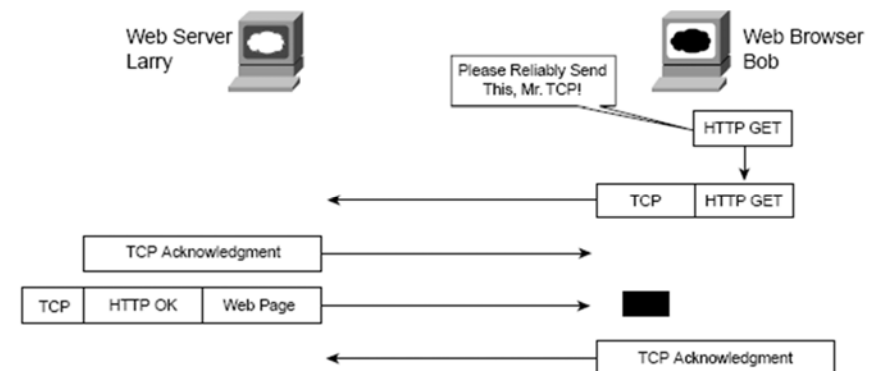

2. The TCP/IP Transport Layer (6)

- assume that if either transmission had been lost, that HTTP would not be concerned, and that TCP would resend the data and ensure that it was received successfully.

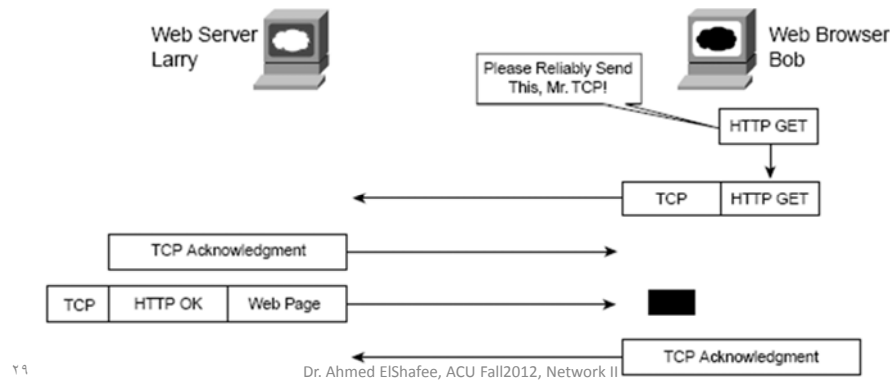

2. The TCP/IP Transport Layer (7)

Adjacent layer interaction concept

So, the higher layer asks for the next lower-layer protocol (TCP) to perform the service, and the next lower layer performs the service. The lower layer provides a service to the layer above it.

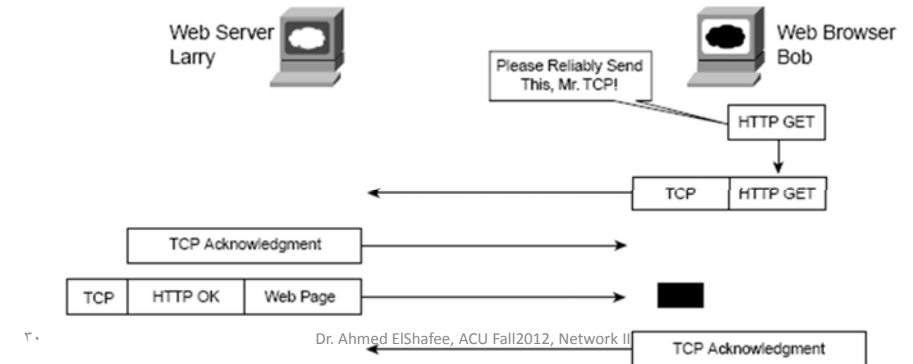

2. The TCP/IP Transport Layer (8)

Concept	Description
Same-layer interaction on different computers	The two computers use a protocol to communicate with the same layer on another computer. The protocol defined by each layer uses a header that is transmitted between the computers, to communicate what each computer wants to do.
Adjacent-layer interaction on the same computer	On a single computer, one layer provides a service to a higher layer. The software or hardware that implements the higher layer requests that the next lower layer perform the needed function.

2. The TCP/IP Transport Layer (9)

Summary

The TCP/IP transport layer provides services to the various application layer protocols. Error recovery, as performed by TCP, is one feature.

3. The TCP/IP Internetwork Layer

Overview

- Imagine that you just wrote a letter to a friend on the other side of the country and that you also wrote a letter to another friend on the other side of town.
- It's time to send the letters. You put different addresses on the envelope for each letter because the letters need to go to two different places.

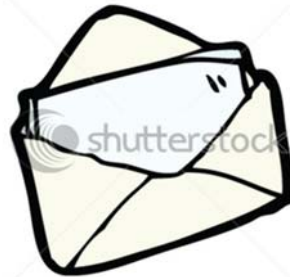

٣٣

Dr. Ahmed ElShafee, ACU Fall2012, Network II

3. The TCP/IP Internetwork Layer (2)

- You put stamps on both letters and put them in the same mailbox.
- The postal service takes care of all the details of figuring out how to get each letter to the right place—whether it is
- across town or across the country.



٣٤

Dr. Ahmed ElShafee, ACU Fall2012, Network II

3. The TCP/IP Internetwork Layer (3)

- Inside the postal service, both letters are processed.
- One letter gets sent to another post office, then another, and so on, until the letter gets delivered across the country.
- The local letter might go to the post office in your town and then simply be delivered to your friend across town, without going to another post office.



٣٥

Dr. Ahmed ElShafee, ACU Fall2012, Network II

3. The TCP/IP Internetwork Layer (4)

- the internetwork layer of the TCP/IP networking model, the Internet Protocol (IP), works much like the postal service.
- IP defines addresses so that each host computer can have a different IP address,
- IP defines the process of routing so that devices called routers can choose where to send packets of data so that they are delivered to the correct destination.

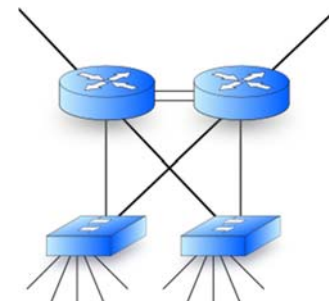

٣٦

Dr. Ahmed ElShafee, ACU Fall2012, Network II

3. The TCP/IP Internetwork Layer (5)

- When Bob sends the data, he is sending an IP packet, which includes the IP header, the transport layer header (TCP, in this example), the application header (HTTP, in this case), and any application data (none, in this case).
- The IP header includes both a source and a destination IP address field, with Larry's IP address as the destination address and Bob's as the source.

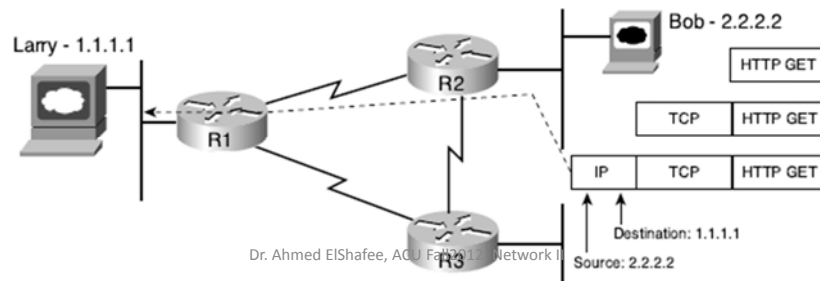

٣٧

Dr. Ahmed ElShafee, ACU Fall2012, Network II

3. The TCP/IP Internetwork Layer (6)

- Bob sends the packet to R2, which makes a routing decision. R2 chooses to send the packet to R1 because the destination address of the packet is 1.1.1.1, and R1 knows enough about the network topology to know that 1.1.1.1 (Larry) is on the other side of R1.

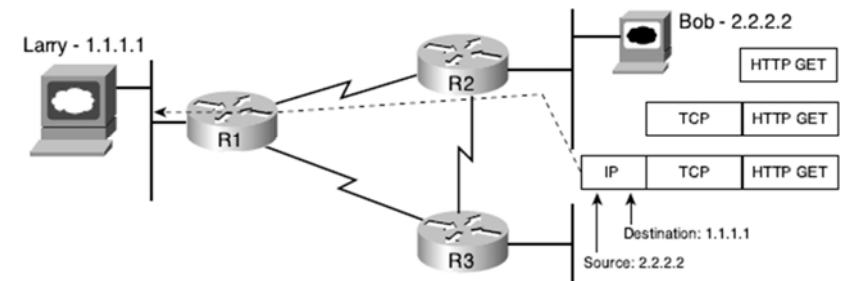

٣٨

3. The TCP/IP Internetwork Layer (7)

- Similarly, when R1 gets the packet, it forwards the packet over the Ethernet to Larry.
- And if the link between R2 and R1 fails, IP allows R2 to learn of the alternate route through R3 to reach 1.1.1.1.

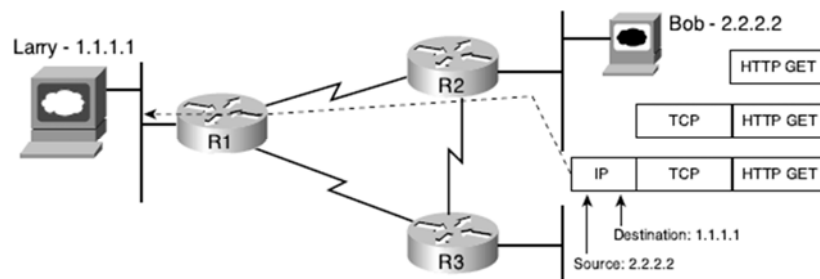

٣٩

Dr. Ahmed ElShafee, ACU Fall2012, Network II

3. The TCP/IP Internetwork Layer (8)

Summary

IP defines logical addresses, called IP addresses, that allow each TCP/IP speaking device (called IP hosts) to communicate. It also defines routing—the process of how a router should forward, or route, packets of data.

٤٠

Dr. Ahmed ElShafee, ACU Fall2012, Network II

4. The TCP/IP Network Interface Layer

Overview

- The term network interface refers to the fact that this layer defines how to connect the host computer, which is not part of the network, to the network;
- Ethernet is one example protocol at the TCP/IP network interface layer.
- Ethernet defines the required cabling, addressing, and protocols used to create an Ethernet LAN. Likewise, the connectors, cables, voltage levels,
- Network interface layer defines protocols used to deliver data across WAN links too.

٤١

Dr. Ahmed ElShafee, ACU Fall2012, Network II

4. The TCP/IP Network Interface Layer (2)

- Just like every layer in any networking model, the TCP/IP network interface layer provides services to the layer above it in the model internetwork layer.
- The best way to understand the basics of the TCP/ IP network interface layer is to examine the services that it provides to IP.

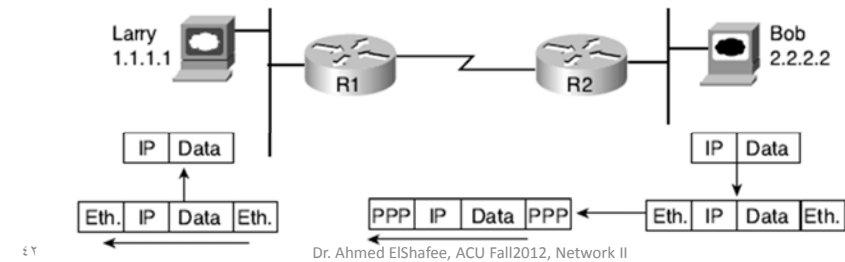

4. The TCP/IP Network Interface Layer (3)

- IP relies on the network interface layer to deliver IP packets across each physical network.
- IP understands the overall network topology, things such as which routers are connected to each other, which host computers are connected to which networks, and what the IP addressing scheme looks like.

٤٢

4. The TCP/IP Network Interface Layer (4)

- However, the IP protocol purposefully does not include the details about each of the underlying physical networks. Therefore, the Internet layer, as implemented by IP, uses the services of the network interface layer to deliver the packets over each physical network, respectively.

٤٣

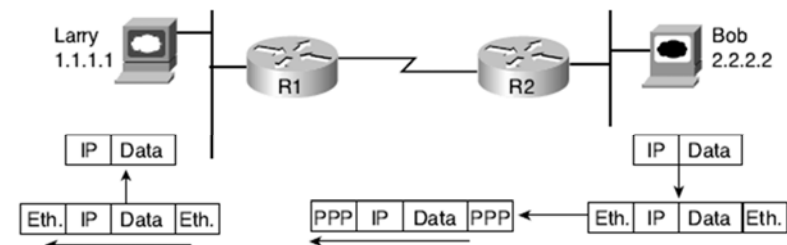
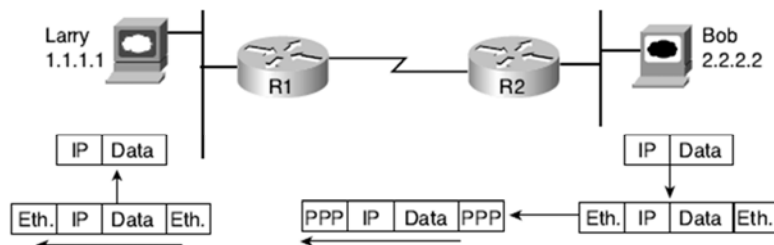

4. The TCP/IP Network Interface Layer (5)

- The network interface layer includes a large number of protocols like Ethernet protocols and other LAN standards.
- This layer also includes the popular WAN standards, such as the Point-to-Point Protocol (PPP) and Frame Relay.

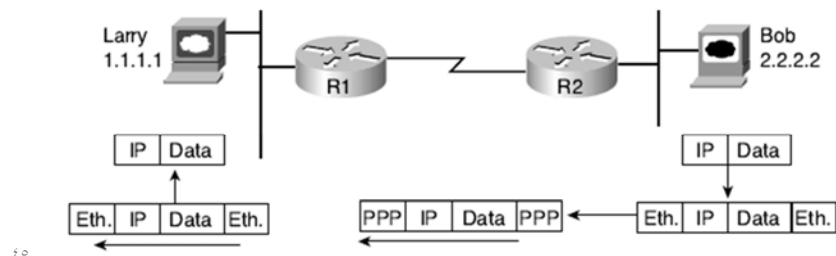

4. The TCP/IP Network Interface Layer (6)

- Bob wants to send the IP packet to Larry, but it must first do so by sending the packet to R2.
- Bob uses Ethernet to get the packet to R2.
- At R2, R2 strips the Ethernet header and trailer from the IP packet. To get the IP packet from R2 to R1,

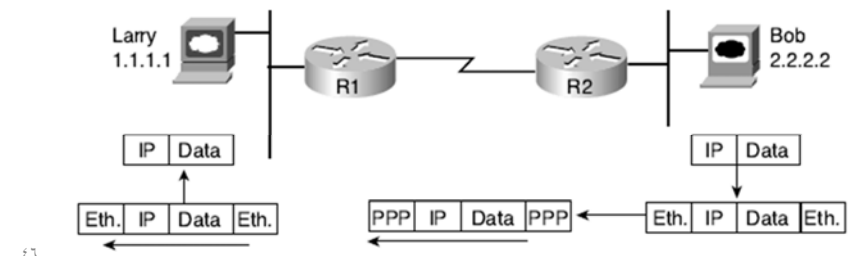

4. The TCP/IP Network Interface Layer (7)

- R2 does not need to use Ethernet—it instead needs to use the PPP serial link. To send the IP packet from R2 to R1, R2 needs to place a PPP header in front of the IP packet and a PPP trailer at the end.
- Similarly, after the packet is received by R1, R1 removes the PPP header and trailer because PPP's job is to get the IP packet across the serial link.

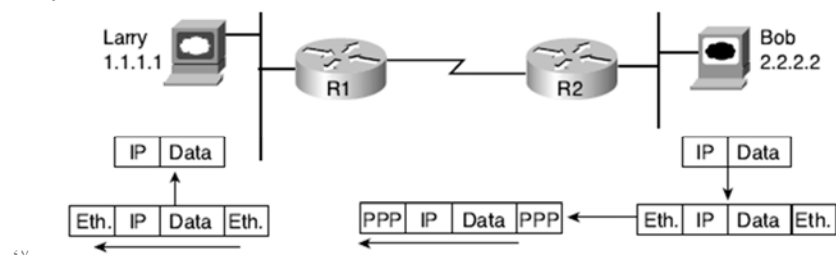

4. The TCP/IP Network Interface Layer (8)

- R1 then decides that it should forward the packet over the Ethernet to Larry.
- To do so, R1 adds a brand-new Ethernet header and trailer to the packet and forwards it to Larry.

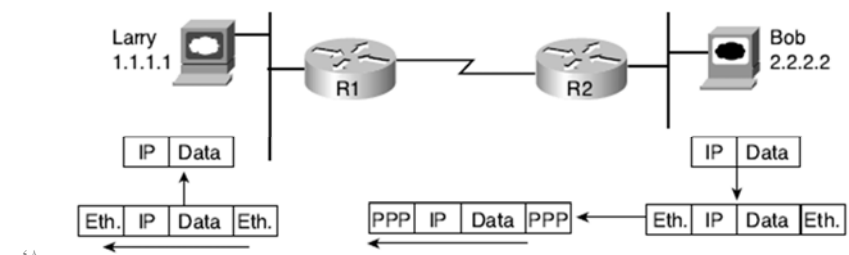

4. The TCP/IP Network Interface Layer (9)

Summary

- IP uses the network interface layer protocols to deliver the IP packet to the next router or host, with each router repeating the process until the packet arrives at the destination.
- Each network interface protocol uses headers to encode the information needed to successfully deliver the data across the physical network, much like other layers use headers to achieve their goals.
- In short, the TCP/IP Network Interface layer includes the protocols, cabling standards, headers and trailers that define how to send data across a wide variety of types of physical networks.

4. The TCP/IP Network Interface Layer (10)

- CAUTION** Many people describe the network interface layer of the TCP/IP model as two layers,
- the data link layer and
 - the physical layer.

Data Encapsulation

What? And why?

The term encapsulation describes the process of putting headers and trailers around some data.

A computer that needs to send data encapsulates the data in headers of the correct format so that the receiving computer will know how to interpret the received data.

Data Encapsulation (2)

Steps:

Regarding the previous Bob and Larry example, encapsulation process consists of 5 successive steps;

Step 1: Create the application data and headers—This simply means that the application has data to send.

Step 2: Package the data for transport—In other words, the transport layer (TCP or UDP) creates the transport header and places the data behind it.

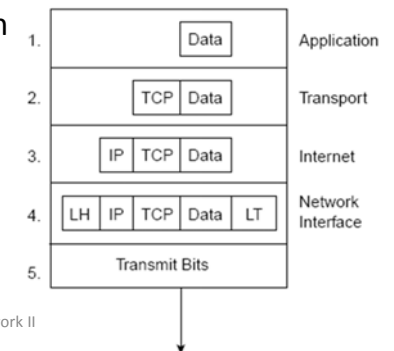

Data Encapsulation (3)

Step 3: Add the destination and source network layer addresses to the data— The network layer creates the network header, which includes the network layer addresses, and places the data behind it.

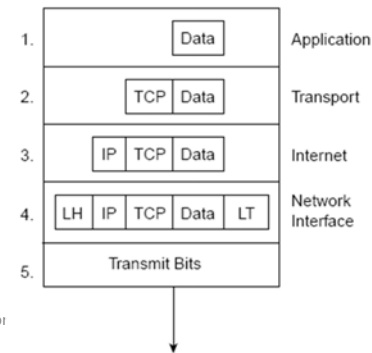

٥٣

Dr. Ahmed ElShafee, ACU Fall2012, Networ

Data Encapsulation (4)

Step 4: Add the destination and source data link layer addresses to the data— The data link layer creates the data link header, places the data behind it, and places the data link trailer at the end.

Step 5: Transmit the bits—The physical layer encodes a signal onto the medium to transmit the frame

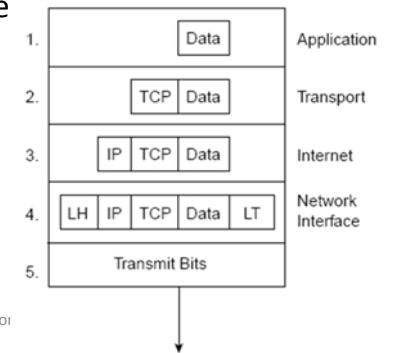

٥٤

Dr. Ahmed ElShafee, ACU Fall2012, Networ

Data Encapsulation (5)

Perspectives on Encapsulation and “Data”

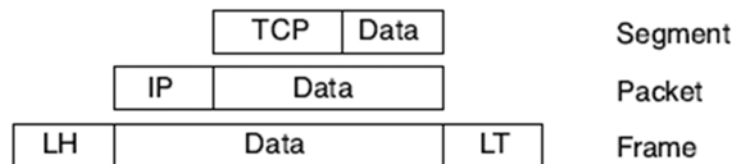

٥٥

Dr. Ahmed ElShafee, ACU Fall2012, Network II

The whole story

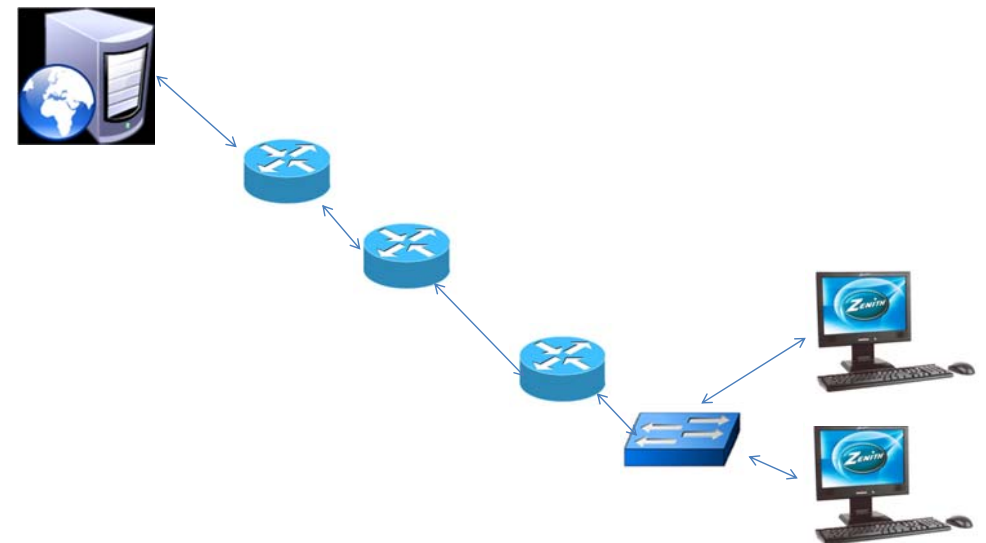

٥٦

Dr. Ahmed ElShafee, ACU Fall2010, Network II

The whole story (2)

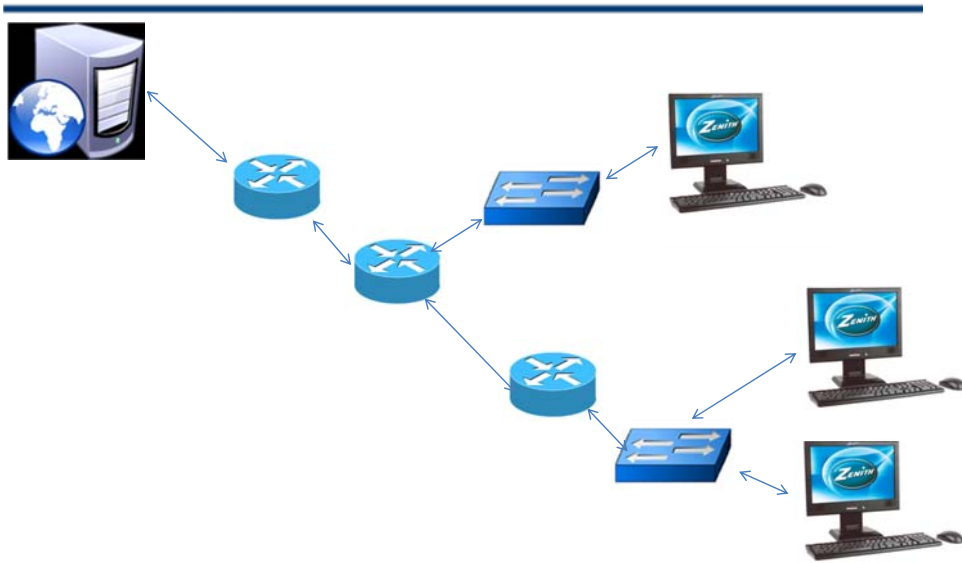

٥٧

Dr. Ahmed ElShafee, ACU Fall2010, Network II

The whole story (3)

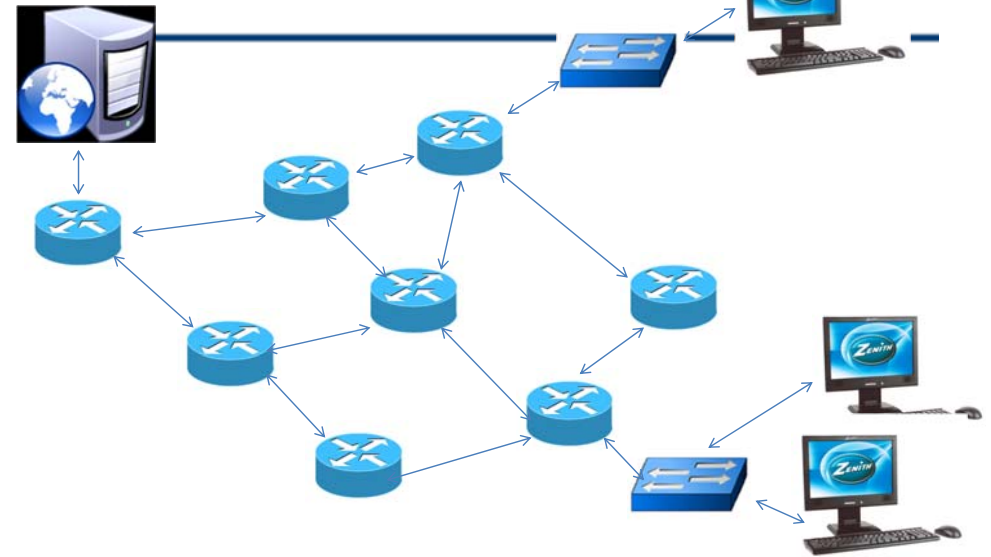

٥٨

Dr. Ahmed ElShafee, ACU Fall2010, Network II

Thanks,..
See you next week (ISA)

٥٩

Dr. Ahmed ElShafee, ACU Fall2012, Network II